













DOORS AND GATES

Table of Contents:

	NEWS	3
	OUTER DOORS	11
	STRUCTURE	11
	GLAZED	25
	GLAZED WITH APPLICATIONS	49
	WITH APPLICATIONS	59
	FULL	63
	DOUBLE-LEAF EXTERIOR DOORS	75
	EXTERIOR DOORS WITH TRANSOMS	79
	ANTI-BURGLARY DOORS	83
	STRUCTURE	83
	WITH EMBOSSING	95
	WITH APPLICATIONS	107
	TECHNICAL DOORS	111
	STRUCTURE	111
	GARAGE SECTIONAL GATES	117
	INDUSTRIAL SECTIONAL GATES	125
	ALUMINIUM JOINERY	133
	DOOR MODELS	137

In individual sections of the catalog we present visualizations of selected models, a full list of embossing, glazing and application patterns can be found in the catalog on pages 137-141 and in the configurator luxsecuritydoors.co.uk

General information

- The price list is valid from March 1, 2022 – all existing price lists expire
- Any information contained in the catalogue does not constitute an offer within the meaning of the Civil Code and is published only for information purposes without any liability
- The drawings in the catalogue are for reference only
- The colors and patterns shown may differ from the actual ones
- Colours from the RAL palette are available on special request
- Custom order extends realization time and increases product price
- The manufacturer reserves the right to make changes to the technical parameters and equipment in the manufactured products without notice
- Declared parameters of Ud coefficients refer to reference dimensions
- All rights reserved ©



Clean Air Program

CLEAN AIR is a nationwide program aimed at improving air quality and reducing greenhouse gas emissions by exchanging heat sources and improving the energy efficiency of single-family houses.

The table below lists the door models manufactured by Lux Security Doors that meet the technical requirements specified in this program.

NAME	THICKNESS	FILLING	GLAZING	FRAME	THRESHOLD	SIZE	Ud W/(m ² xK)
MASTERTHERM	101mm	POLYURETHANE FOAM	FULL	STEEL- -WOOD	ALUMINUM	1000	0,63
						900	0,65
						800	0,68
MASTERTHERM	101mm	POLYURETHANE FOAM	GLAZED	STEEL- -WOOD	ALUMINUM	1000	0,70
						900	0,73
						800	0,76
85 PREMIUM PLUS 85 PREMIUM H PLUS	85 mm	POLYURETHANE FOAM	FULL	STEEL- -WOOD	ALUMINUM	REF. DIM.	0,91
85 PREMIUM PLUS 85 PREMIUM H PLUS	85 mm	POLYURETHANE FOAM	GLAZED	STEEL- -WOOD	ALUMINUM	REF. DIM.	1,0
85 PREMIUM	85 mm	POLYURETHANE FOAM	FULL	STEEL	STEEL	REF. DIM.	1,1
85 PREMIUM	85 mm	POLYURETHANE FOAM	GLAZED	STEEL	STEEL	REF. DIM.	1,3
85 STANDARD	85 mm	FOAMED POLYSTYRENE	FULL	STEEL	STEEL	REF. DIM.	1,2
85 STANDARD	85 mm	FOAMED POLYSTYRENE	GLAZED	STEEL	STEEL	REF. DIM.	1,3
72 PREMIUM PLUS 72 PREMIUM H PLUS	72 mm	POLYURETHANE FOAM	FULL	STEEL- -WOOD	ALUMINUM	REF. DIM.	1,0
72 PREMIUM PLUS 72 PREMIUM H PLUS	72 mm	POLYURETHANE FOAM	GLAZED PVC/INOX	STEEL- -WOOD	ALUMINUM	REF. DIM.	1,2
72 PREMIUM	72 mm	POLYURETHANE FOAM	FULL	STEEL	STEEL	REF. DIM.	1,2
72 PREMIUM	72 mm	POLYURETHANE FOAM	GLAZED	STEEL	STEEL	REF. DIM.	1,3
72 STANDARD	72 mm	FOAMED POLYSTYRENE	FULL	STEEL	STEEL	REF. DIM.	1,3
55 PREMIUM PLUS	55 mm	POLYURETHANE FOAM	FULL	STEEL- -WOOD	ALUMINUM	REF. DIM.	1,2
55 PREMIUM	55 mm	POLYURETHANE FOAM	FULL	STEEL	STEEL	REF. DIM.	1,2

NAME	THICKNESS	FILLING	GLAZING	FRAME	THRESHOLD	SIZE	Ud W/(m2xk)
OTHER MANUFACTURING OPTIONS	85 mm	POLYURETHANE FOAM	FULL	ALUMINUM	ALUMINUM	REF. DIM.	0,85
	85 mm	POLYURETHANE FOAM	GLAZED	ALUMINUM	ALUMINUM	REF. DIM.	0,96
	85 mm	FOAMED POLYSTYRENE	FULL	ALUMINUM	ALUMINUM	REF. DIM.	0,93
	85 mm	FOAMED POLYSTYRENE	GLAZED	ALUMINUM	ALUMINUM	REF. DIM.	1,0
	72 mm	POLYURETHANE FOAM	FULL	STEEL- -WOOD	STEEL	REF. DIM.	1,0
	72 mm	POLYURETHANE FOAM	FULL	ALUMINUM	STEEL	REF. DIM.	1,1
	72 mm	FOAMED POLYSTYRENE	FULL	STEEL- -WOOD	ALUMINUM	REF. DIM.	1,1
	72 mm	FOAMED POLYSTYRENE	FULL	ALUMINUM	STEEL	REF. DIM.	1,2
	72 mm	POLYURETHANE FOAM	GLAZED	STEEL- -WOOD	STEEL	REF. DIM.	1,3
	72 mm	POLYURETHANE FOAM	GLAZED	ALUMINUM	STEEL	REF. DIM.	1,3
	72 mm	FOAMED POLYSTYRENE	GLAZED PVC	STEEL- -WOOD	ALUMINUM	REF. DIM.	1,3
	55 mm	POLYURETHANE FOAM	FULL	ALUMINUM	STEEL	REF. DIM.	1,1
	55 mm	POLYURETHANE FOAM	FULL	STEEL- -WOOD	STEEL	REF. DIM.	1,1
	55 mm	FOAMED POLYSTYRENE	FULL	STEEL- -WOOD	STEEL	REF. DIM.	1,3

New doors

New in the offer of Lux Security Doors –**energy-saving** doors with a thickness of 85 mm are made in the following configurations:

■ 85 Premium H Plus with a MACO strip lock.

A unique lock equipped with three tongues with a silent pawl allows you to maintain even pressure on the gasket from both the hinge and the lock side, eliminating potential blowbacks while maintaining maximum safety and comfort of use – when the door is locked, the pawls lock acting as bolts.

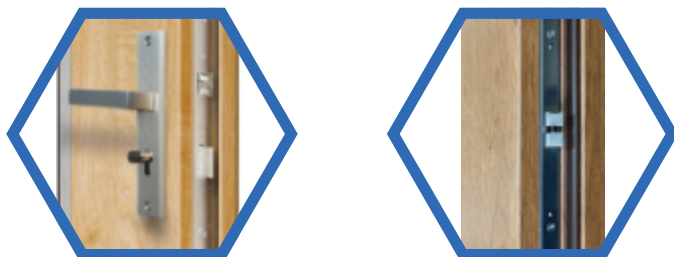

Filling with polyurethane foam and the use of a steel-wood frame equipped with a new, reinforced –two–spindle 3D hinge, as well as an aluminum threshold allow to obtain excellent thermal parameters of **Ud from 0.89 W/(m²*K)** for full doors.

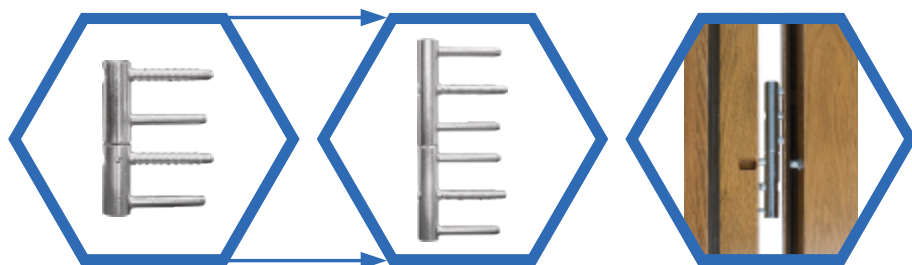

- 85 Premium Plus
- 85 Premium
- 85 Standard

The structure and equipment of the doors and the manufacturing options are described in detail on pages 13–16.

Doors with a thickness of 85 mm are made in the following colors:

White, Turner Oak, Winchester, Golden Oak, Dark Walnut, Swamp Oak, Dark Anthracite, Wood-like Anthracite and are available in sizes 80N –80E –90N –90E.



New Laminate Colors

A wide selection and a wide range of color laminates in the offer of Stalprodukt-Zamość are complemented with two new colors.



Light grey is a laminate with a delicate structure in a colour similar to RAL7040. Minimalist, versatile color is perfect for modern interiors, often used in residential construction.



Turner Oak is a steel response to the increasingly visible need to return to colours similar to natural wood. Warm shade and illusion of a grain structure give the interior a unique character.

New door frames

Fd-25/21P-1 and Fd-25/21P-2

Two new models of steel frame laminated or painted for installation inside the wall (Fd-25/21P-2) or corner (Fd-25/21P-1) designed for connection to the MDF panel. The new door frames are used in residential construction and can be used in anti-burglary doors with a thickness of 55 mm. Valuation on individual inquiries.

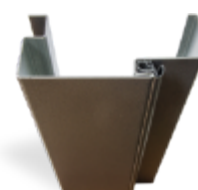
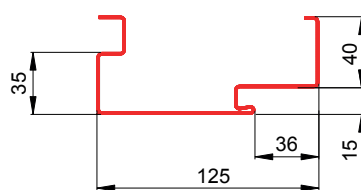
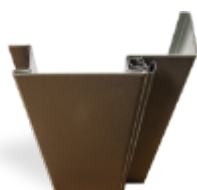
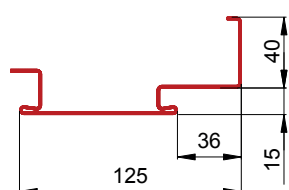

New glazed doors with applications

Among the novelties planned for 2022, we present you a glazed door with a double-sided application. It is a proposition for those customers who appreciate unique stylistics emphasizing the individual preferences of the owners.

We encourage you to read the propositions in the inox and black versions.



Veneer colors available

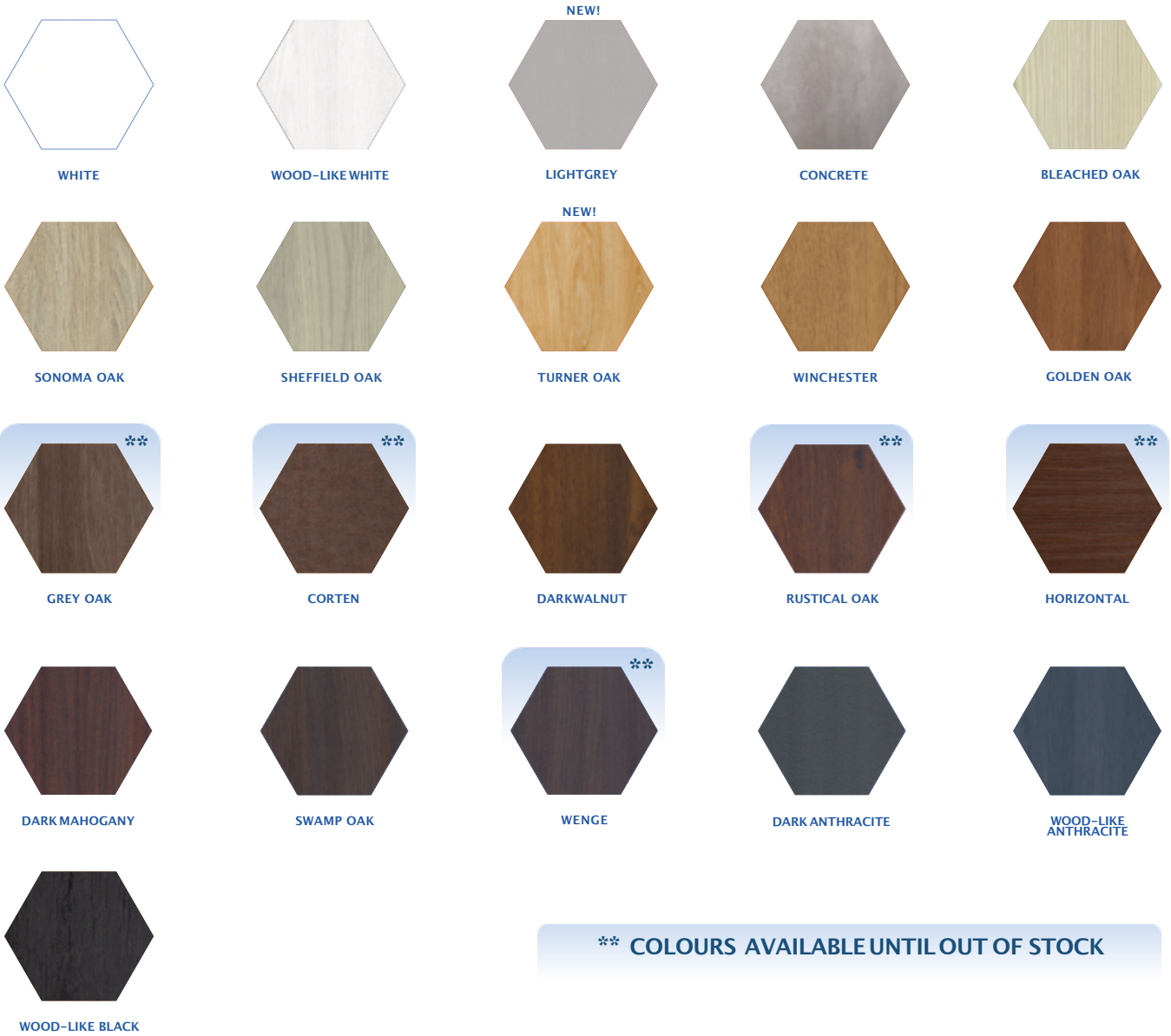

Determining the door opening direction

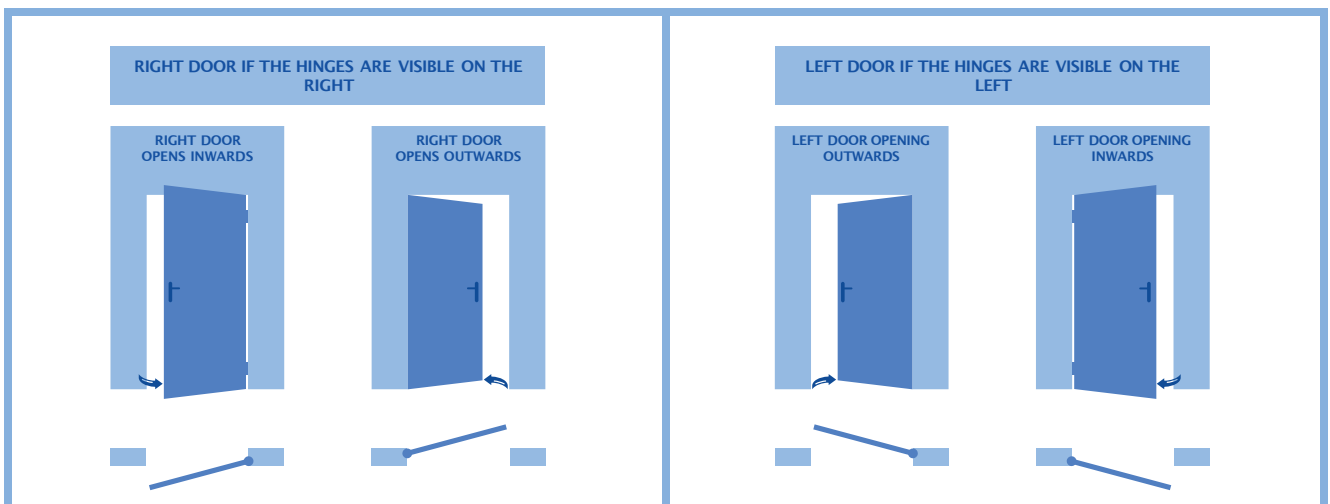



OUTER DOORS



STRUCTURE

DOOR STRUCTURE

101MASTERTHERM

 Ud od 0,63 W/(m²*K)
FULL DOOR

 Ud od 0,70 W/(m²*K)
GLAZED DOOR

 Rw = 30 dB
ACOUSTIC INSULATION INDEX

LEAF WITH A THICKNESS OF 101MM WITH A FOUR-SIDED ABUTMENT, THE CONSTRUCTION OF WHICH IS BASED ON A FULL WOODEN FRAME, MADE OF GALVANIZED LAMINATED METAL SHEET 0.6 MM THICK, FILLED WITH POLYURETHANE FOAM, EQUIPPED WITH TWO GASKETS

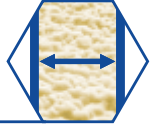

FOUR ANTI-BRAKEIN PINS ON DOOR HINGE SIDE



THREE 3DHINGES WITH GUARDS ADJUSTABLE IN THREE PLANES



MULTI-POINTHOOK AND PIN LOCK WITH QUIET PAWL

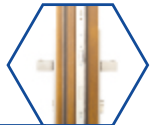

THREE HOOK STRIP-LOCKWITH ADJUSTABLE CLAMP

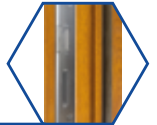

STEEL-WOODFRAME CONSISTING OF GALVANIZED METAL SHEET 0.6 MM THICK AND A PINE GUSSET, LAMINATED IN LEAF COLOR, FITTED WITH A GASKET



INTEGRATEDALUMINIUM DOOR SILL WITH THERMAL SEPARATOR

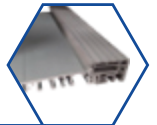

HANDLE STP-H



KNOB-INSERT



OPTIONS FOR MANUFACTURING ATAN EXTRA CHARGE



ATTESTED
INSERT IN CLASS B



SAFETY CLASS RC2 FOR
FULL DOORS

85 PREMIUM H PLUS



FULL DOOR



GLAZED DOOR



ACOUSTIC INSULATION INDEX

CUSTOM
DIMENSION
DOOR

LEAF THICKNESS 85 MM WITH TRIANGULAR ABUTMENT,
MADE OF GALVANIZED LAMINATED METAL SHEET 0.6 MM THICK,
FILLED WITH POLYURETHANE FOAM,
EQUIPPED WITH GASKET



THREE ANTI-BRAKE IN PINS
ON DOOR HINGE SIDE



THREE REINFORCED, DOUBLE-PIVOT,
3D HINGES WITH GUARDS ADJUSTABLE IN THREE PLANES



MACO MULTIPOINT SLATTED LOCK
WITH THREE TONGUES WITH SILENT PAWL



THREE HOOK STRIP-LOCK
WITH ADJUSTABLE CLAMP



STEEL-WOOD FRAME CONSISTING OF
GALVANIZED METAL SHEET 0.6-1.2 MM THICK AND PINE SIZING
LAMINATED IN LEAF COLOR,
FITTED WITH A GASKET

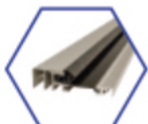

INTEGRATED WITH THE FRAME
ALUMINIUM THRESHOLD WITH THERMAL SEPARATOR



HANDLE STP-H



KNOB-INSERT



DOOR STRUCTURE

85 PREMIUM PLUS

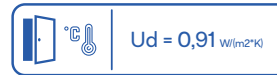

Ud = 0,91 W/(m²*K)

FULL DOOR



Ud = 1,0 W/(m²*K)

GLAZED DOOR



Rw = 30 dB

ACOUSTIC INSULATION INDEX



CUSTOM DIMENSION DOOR

85 MM THICK LEAF WITH TRIANGULAR ABUTMENT, MADE OF GALVANIZED LAMINATED METAL SHEET 0.6 MM THICK, FILLED WITH POLYURETHANE FOAM, EQUIPPED WITH TWO GASKETS



THREE ANTI-BRAKEIN PINS ON DOOR HINGE SIDE



THREE REINFORCED, DOUBLE-PIVOT, 3D HINGES WITH GUARDS ADJUSTABLE IN THREE PLANES



THREE-BOLT TOP LOCK



THREE-BOLT MAIN LOCK



LOCK HOOKS WITH ADJUSTABLE PRESSURE



STEEL-WOODFRAME CONSISTING OF GALVANIZED METAL SHEET 0.6-1.2MM THICK AND A PINE SIZING, LAMINATED IN LEAF COLOR, FITTED WITH A GASKET



INTEGRATED ALUMINIUM DOOR THRESHOLD WITH THERMAL SEPARATOR

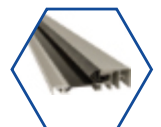





HANDLE STP-H



INSERT AND KNOB-INSERT



85 PREMIUM

 $U_d = 1,1 \text{ W/(m}^2\text{K)}$	 $U_d = 1,3 \text{ W/(m}^2\text{K)}$
FULL DOOR	GLAZED DOOR
 CUSTOM DIMENSION DOOR	 $R_w = 30 \text{ dB}$
ACOUSTIC INSULATION INDEX	

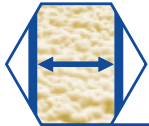

85MM THICK LEAF WITH TRIANGULAR ABUTMENT, MADE OF GALVANIZED LAMINATED METAL SHEET 0.6 MM THICK, FILLED WITH POLYURETHANE FOAM, EQUIPPED WITH GASKET



THREE ANTI-BRAKEIN PINS ON DOOR HINGE SIDE



THREE THREE-PIECE HINGES Z5



THREE-BOLT TOP LOCK



THREE-BOLT MAIN LOCK



LOCK HOOKS WITH ADJUSTABLE CLAMP



STEEL FRAME MADE OF GALVANIZED METAL SHEET 1.2MM THICK, LAMINATED IN LEAF COLOR, EQUIPPED WITH GASKET

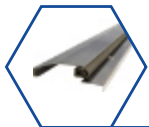

INTEGRATED STEEL THRESHOLD WITH GASKET



HANDLE STP-H



INSERT AND KNOB-INSERT



FRAME MODELS AVAILABLE

STANDARD



FD-25/21/B

EXTRA CHARGE



ALUMINIUM WITH THERMAL SEPARATOR



STEEL-WOOD WITH 3D HINGE

DOOR STRUCTURE

85 STANDARD

Ud = 1,2 W/m²*Kl

FULL DOOR

Ud = 1,3 W/m²*Kl

GLAZED DOOR

Rw = 30 dB

ACOUSTIC INSULATION INDEX

CUSTOM DIMENSION DOOR



85 MM THICK LEAF WITH TRIANGULAR ABUTMENT, MADE OF GALVANIZED LAMINATED METAL SHEET 0.6 MM THICK, FILLED WITH FOAMED POLYSTYRENE, EQUIPPED WITH GASKET

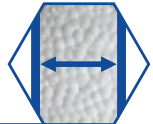

THREE ANTI-BRAKEIN PINS ON DOOR HINGE SIDE



THREE THREE-PIECE HINGES Z5



THREE-BOLT TOP LOCK



THREE-BOLT MAIN LOCK



LOCK HOOKS WITH ADJUSTABLE PRESSURE



STEEL FRAME MADE OF GALVANIZED METAL SHEET 1.2MM THICK, LAMINATED IN LEAF COLOR, FITTED WITH A GASKET



INTEGRATED STEEL THRESHOLD WITH GASKET

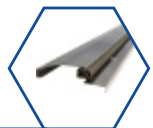

HANDLE STP-H



INSERT AND KNOB-INSERT



FRAME MODELS AVAILABLE

STANDARD



FD-25/21/B

EXTRA CHARGE



72PREMIUM H PLUS

Ud = 1,0 W/(m²*K)

FULL DOOR

Ud = 1,2 W/(m²*K)

GLAZED DOOR



Rw = 30 dB

ACOUSTIC INSULATION INDEX

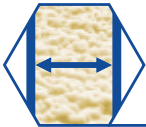
CUSTOM
DIMENSION
DOOR

72MM THICK LEAF WITH TRIANGULAR ABUTMENT,
MADE OF GALVANIZED LAMINATED METAL SHEET 0.6 MM THICK,
FILLED WITH POLYURETHANE FOAM,
EQUIPPED WITH GASKET



THREE ANTI-BRAKEIN PINS ON DOOR HINGE SIDE



THREE 3D HINGES WITH GUARDS ADJUSTABLE IN THREE PLANES



WINKHAUS MULTI-POINT STRIP-HOOK LOCK



THREE HOOK STRIP-LOCK WITH ADJUSTABLE CLAMP



STEEL-WOOD FRAME MADE OF GALVANIZED
METAL SHEET 0.6-1.2MM THICK AND PINE SIZING
LAMINATED IN LEAF COLOR,
FITTED WITH A GASKET

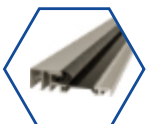

INTEGRATED WITH THE FRAME
ALUMINIUM THRESHOLD WITH THERMAL SEPARATOR

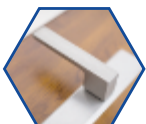

HANDLE STP-H



KNOB-INSERT



DOOR STRUCTURE

72PREMIUM PLUS



Ud = 1,0 W/(m²K)

FULL DOOR



Ud = 1,2 W/(m²K)

GLAZED DOOR



Rw = 30 dB

ACOUSTIC INSULATION INDEX



CUSTOM DIMENSION DOOR

72 MM THICK LEAF WITH TRIANGULAR ABUTMENT, MADE OF GALVANIZED LAMINATED METAL SHEET 0.6 MM THICK, FILLED WITH POLYURETHANE FOAM, EQUIPPED WITH A GASKET

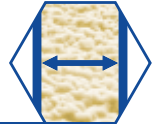

THREE ANTI-BRAKEIN PINS ON DOOR HINGE SIDE



THREE 3D HINGES WITH GUARDS ADJUSTABLE IN THREE PLANES



THREE-BOLT TOP LOCK



THREE-BOLT MAIN LOCK



LOCK HOOKS WITH ADJUSTABLE CLAMP



STEEL-WOOD FRAME MADE OF GALVANIZED METAL SHEET 0.6-1.2MM THICK AND A PINE SIZING, LAMINATED IN LEAF COLOR, FITTED WITH A GASKET



INTEGRATED ALUMINIUM DOOR THRESHOLD WITH THERMAL SEPARATOR

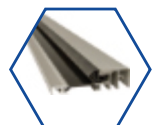

HANDLE STP-H



INSERT AND KNOB-INSERT WITH ONE KEY SYSTEM



72 PREMIUM

Ud = 1,2 W/(m²*K)

FULL DOOR

Ud = 1,3 W/(m²*K)

GLAZED DOOR

CUSTOM
DIMENSION
DOOR

Rw = 30 dB

ACOUSTIC INSULATION INDEX

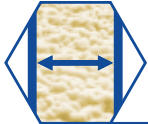

72MM THICK LEAF WITH TRIANGULAR ABUTMENT,
MADE OF GALVANIZED LAMINATED METAL SHEET 0.6 MM THICK,
FILLED WITH POLYURETHANE FOAM,
EQUIPPED WITH GASKET



THREE ANTI-BRAKEIN PINS ON DOOR HINGE SIDE



THREE THREE-PIECE HINGES Z5



THREE-BOLT TOP LOCK



THREE-BOLT MAIN LOCK



LOCK HOOKS WITH ADJUSTABLE CLAMP



STEEL FRAME
MADE OF GALVANIZED METAL SHEET 1.2MM THICK,
LAMINATED IN LEAF COLOR,
EQUIPPED WITH GASKET

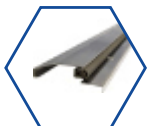

INTEGRATED STEEL THRESHOLD WITH GASKET



HANDLE STP-H



INSERT AND KNOB-INSERT WITH ONE KEY SYSTEM



FRAME MODELS AVAILABLE

STANDARD



FD-25/12



FD-25/21/B

EXTRA CHARGE

ALUMINIUM WITH
THERMAL SEPARATORSTEEL-WOOD WITH
3D HINGEFD-25/12 +
COVER

DOOR STRUCTURE

72 STANDARD

Ud = 1,3 W/(m²*K)

FULL DOOR

Ud = 1,5 W/(m²*K)

GLAZED DOOR

Rw = 30 dB

ACOUSTIC INSULATION INDEX

CUSTOM DIMENSION DOOR

72 MM THICK LEAF WITH TRIANGULAR ABUTMENT, MADE OF GALVANIZED LAMINATED METAL SHEET 0.6 MM THICK, FILLED WITH FOAMED POLYSTYRENE, EQUIPPED WITH GASKET

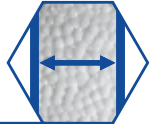

THREE ANTI-BRAKEIN PINS ON DOOR HINGE SIDE



THREE THREE-PIECE HINGES Z5



THREE-BOLT TOP LOCK



THREE-BOLT MAIN LOCK



LOCK HOOKS WITH ADJUSTABLE CLAMP



STEEL FRAME MADE OF GALVANIZED METAL SHEET 1.2MM THICK, LAMINATED IN LEAF COLOR, FITTED WITH A GASKET



INTEGRATED STEEL THRESHOLD WITH GASKET

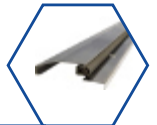

HANDLE STP-H



INSERT AND KNOB-INSERT WITH ONE KEY SYSTEM



FRAME MODELS AVAILABLE

STANDARD



FD-25/12



FD-25/21/B

EXTRA CHARGE



ALUMINIUM WITH THERMAL SEPARATOR



STEEL-WOOD WITH 3D HINGE



FD-25/12 + COVER

55 PREMIUM PLUS



FULL DOOR



GLAZED DOOR

CUSTOM
DIMENSION
DOOR

Rw = 27 dB

ACOUSTIC INSULATION INDEX

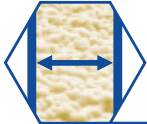

55MM THICK LEAF WITH TRIANGULAR ABUTMENT,
MADE OF GALVANIZED LAMINATED METAL SHEET 0.6 MM THICK,
FILLED WITH POLYURETHANE FOAM,
EQUIPPED WITH GASKET



THREE ANTI-BRAKEIN PINS ON DOOR HINGE SIDE

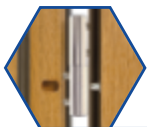

THREE 3D HINGES WITH GUARDS ADJUSTABLE IN THREE PLANES



THREE-BOLT TOP LOCK



THREE-BOLT MAIN LOCK



LOCK HOOKS WITH ADJUSTABLE CLAMP



STEEL-WOOD FRAME MADE OF GALVANIZED
METAL SHEET 0.6-1.2MM THICK AND PINE SIZING
LAMINATED IN LEAF COLOR,
FITTED WITH A GASKET

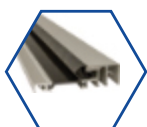

INTEGRATED WITH THE FRAME
ALUMINIUM THRESHOLD WITH THERMAL SEPARATOR



HANDLE STP-H



INSERT AND KNOB-INSERT WITH ONE KEY SYSTEM



DOOR STRUCTURE

55 PREMIUM

Ud = 1,2 W/(m²*K)

FULL DOOR

Ud = 1,5 W/(m²*K)

GLAZED DOOR

Rw = 27 dB

ACOUSTIC INSULATION INDEX

CUSTOM DIMENSION DOOR

55 MM THICK LEAF WITH TRIANGULAR ABUTMENT, MADE OF GALVANIZED LAMINATED METAL SHEET 0.6 MM THICK, FILLED WITH POLYURETHANE FOAM, EQUIPPED WITH A GASKET

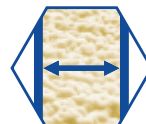

THREE ANTI-BRAKEIN PINS ON DOOR HINGE SIDE



THREE THREE-PIECE HINGES Z5



THREE-BOLT TOP LOCK



THREE-BOLT MAIN LOCK



LOCK HOOKS WITH ADJUSTABLE CLAMP



STEEL FRAME MADE OF GALVANIZED METAL SHEET 1.2MM THICK, LAMINATED IN LEAF COLOR, FITTED WITH A GASKET



INTEGRATED STEEL THRESHOLD WITH GASKET

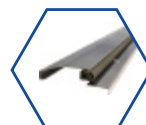

HANDLE STP-H



INSERT AND KNOB-INSERT WITH ONE KEY SYSTEM



FRAME MODELS AVAILABLE

STANDARD



FD-25/12



FD-25/21/B



FD-25/21/C

EXTRA CHARGE



ALUMINIUM WITH THERMAL SEPARATOR



STEEL-WOOD WITH 3D HINGE



FD-25/12 + COVER



Ud = 1,4 W/(m²*K)

FULL DOOR



Ud = 1,6 W/(m²*K)

GLAZED DOOR



CUSTOM DIMENSION DOOR



Rw = 27 dB

ACOUSTIC INSULATION INDEX

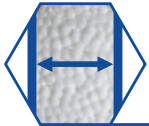

55MM THICK LEAF WITH TRIANGULAR ABUTMENT, MADE OF GALVANIZED LAMINATED METAL SHEET 0.6 MM THICK, FILLED WITH FOAMED POLYSTYRENE, EQUIPPED WITH GASKET



THREE ANTI-BRAKEIN PINS ON DOOR HINGE SIDE



THREE THREE-PIECE HINGES Z5



THREE-BOLT TOP LOCK

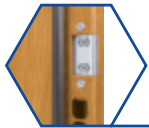

LOCK HOOKS WITH ADJUSTABLE CLAMP



STEEL FRAME MADE OF GALVANIZED METAL SHEET 1.2MM THICK, LAMINATED IN LEAF COLOR, EQUIPPED WITH GASKET

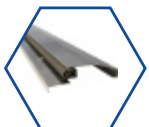

INTEGRATED STEEL THRESHOLD WITH GASKET







HANDLE STP-H



INSERT AND KNOB-INSERT WITH ONE KEY SYSTEM



FRAME MODELS AVAILABLE

STANDARD				EXTRA CHARGE			
	FD-25/12	FD-25/21/B	FD-25/21/C		ALUMINIUM WITH THERMAL SEPARATOR	STEEL-WOOD WITH 3DHINGE	FD-25/12 + COVER





EXTERIOR DOORS

GLAZED

STANDARD COLORS

- WHITE *
- WOOD-LIKE WHITE *
- LIGHTGREY
- CONCRETE
- BLEACHED OAK
- SONOMAOAK
- SHEFFIELD OAK
- WINCHESTER *
- GOLDEN OAK *
- GREY OAK ***
- CORTEN ***
- DARKWALNUT *
- RUSTICAL OAK ***
- HORIZONTAL ***
- DARKMAHOGANY
- SWAMP OAK *
- WENGE ***
- DARKANTHRACITE *
- WOOD-LIKE ANTHRACITE *

EXCLUSIVE COLORS

- TURNER OAK *
 - WOOD-LIKE BLACK
- COLORS AVAILABLE UNTIL OUT OF STOCK **

GLAZED EXTERIOR DOOR

EMBOSSING T41

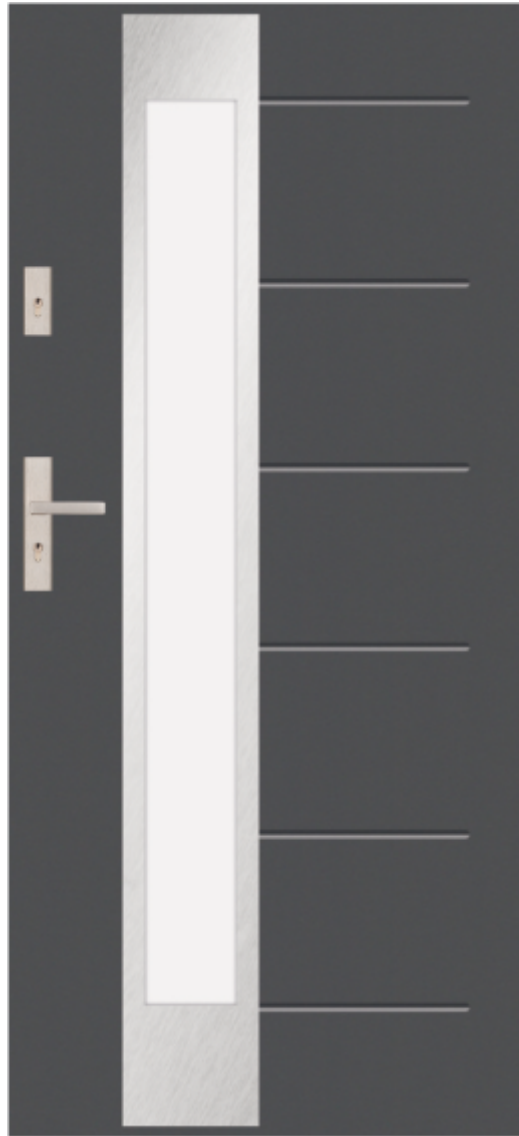

GLAZING S37

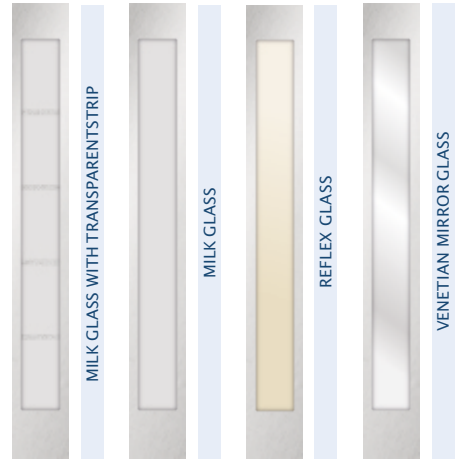

FRAMES AVAILABLE IN COLORS INOX AND BLACK

	Ud
55 STANDARD	1,6
55 PREMIUM	1,5
55 PREMIUM PLUS	1,5
72 STANDARD	1,5
72 PREMIUM	1,3
72 PREMIUM PLUS	1,2
72 PREMIUM H PLUS	1,2
85 STANDARD	1,3
85 PREMIUM	1,3
85 PREMIUM PLUS	1,0
85 PREMIUM H PLUS	1,0
101 MASTER THERM	0,70

AVAILABLE SIZES:
80N, 80E, 90N, 90E, 100N, 100E

DOORS IN SIZE 100N, 100E ONLY AVAILABLE IN COLORS MARKED WITH *

DOORS 85 MM THICK ARE MADE IN THE FOLLOWING COLORS:
WHITE, TURNER OAK, WINCHESTER, GOLDEN OAK, DARK WALNUT, SWAMP OAK, DARKANTHRACITE, WOOD-LIKE ANTHRACITE
ARE AVAILABLE IN SIZES 80N, 80E, 90N, 90E.

GLAZED EXTERIOR DOOR



G
S37



T41
S37



T41
S37

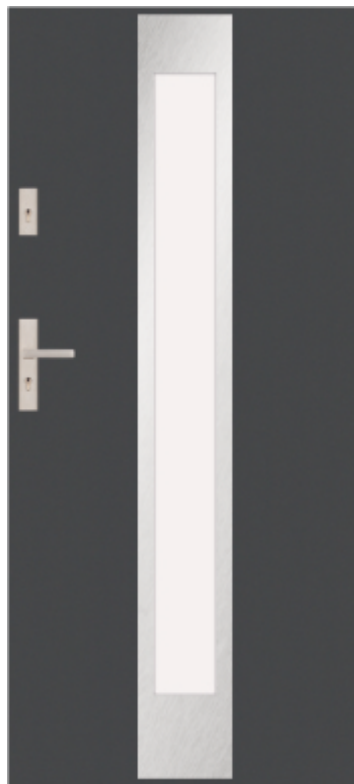

G
S37

STANDARD COLORS

-  * WHITE
-  WOOD-LIKE WHITE
-  LIGHTGREY
-  CONCRETE
-  BLEACHED OAK
-  SONOMAOAK
-  SHEFFIELD OAK
-  * WINCHESTER
-  * GOLDEN OAK
-  ** GREY OAK
-  ** CORTEN
-  * DARKWALNUT
-  ** RUSTICAL OAK
-  ** HORIZONTAL
-  DARKMAHOGANY
-  * SWAMP OAK
-  ** WENGE
-  * DARKANTHRACITE
-  * WOOD-LIKE ANTHRACITE

EXCLUSIVE COLORS

-  * TURNER OAK
-  WOOD-LIKE BLACK

** COLORS AVAILABLE UNTIL OUT OF STOCK

STANDARD COLORS

- WHITE 
- WOOD-LIKE WHITE 
- WINCHESTER 
- GOLDEN OAK 
- DARKWALNUT 
- RUSTICAL OAK 
- DARKMAHOAGANY 
- SWAMP OAK 
- WENGE 
- DARKANTHRACITE 

COLORS AVAILABLE UNTIL OUT OF STOCK **

GLAZED EXTERIOR DOOR

EMBOSSING T52



GLAZING S03

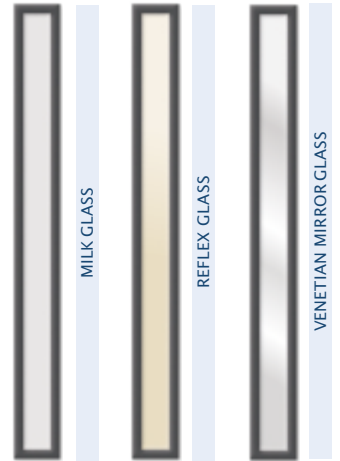

PVC FRAMES IN VENEER COLORS

	Ud
55 STANDARD	1,6
55 PREMIUM	1,5
55 PREMIUM PLUS	1,5
72 STANDARD	1,5
72 PREMIUM	1,3
72 PREMIUM PLUS	1,2
72 PREMIUM H PLUS	1,2
85 STANDARD	X
85 PREMIUM	X
85 PREMIUM PLUS	X
85 PREMIUM H PLUS	X
101 MASTER THERM	X

AVAILABLE SIZES:
80N, 80E, 90N, 90E, 100N, 100E

DOORS IN SIZE 100N, 100E ONLY AVAILABLE IN COLORS MARKED WITH *

GLAZED EXTERIOR DOOR

STANDARD COLORS



G
S03



T52
S03



T52
S03



G
S03



WHITE



WOOD-LIKE
WHITE



WINCHESTER



GOLDEN OAK



DARKWALNUT

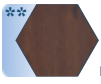

RUSTICAL OAK



DARKMAHOGANY



SWAMP OAK

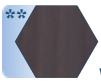

WENGE

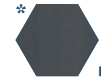

DARKANTHRACITE



COLORS AVAILABLE
UNTIL OUT OF STOCK

STANDARD COLORS

- WHITE *
- WOOD-LIKE WHITE
- LIGHTGREY
- CONCRETE
- BLEACHED OAK
- SONOMAOAK
- SHEFFIELD OAK
- WINCHESTER *
- GOLDEN OAK *
- GREY OAK ***
- CORTEN ***
- DARKWALNUT *
- RUSTICAL OAK ***
- HORIZONTAL ***
- DARKMAHOGANY
- SWAMP OAK *
- WENGE ***
- DARKANTHRACITE *
- WOOD-LIKE ANTHRACITE *

EXCLUSIVE COLORS

- TURNER OAK *
 - WOOD-LIKE BLACK
- COLORS AVAILABLE UNTIL OUT OF STOCK *****

GLAZED EXTERIOR DOOR

EMBOSSING T63



GLAZING S34

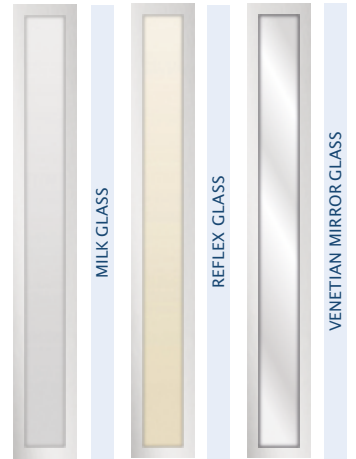

FRAMES AVAILABLE IN COLORS INOX AND BLACK

	Ud
55 STANDARD	1,6
55 PREMIUM	1,5
55 PREMIUM PLUS	1,5
72 STANDARD	1,5
72 PREMIUM	1,3
72 PREMIUM PLUS	1,2
72 PREMIUM H PLUS	1,2
85 STANDARD	1,3
85 PREMIUM	1,3
85 PREMIUM PLUS	1,0
85 PREMIUM H PLUS	1,0
101 MASTER THERM	0,70

AVAILABLE SIZES:
80N, 80E, 90N, 90E, 100N, 100E

DOORS IN SIZE 100N, 100E ONLY AVAILABLE IN COLORS MARKED WITH *

DOORS 85 MM THICK ARE MADE IN THE FOLLOWING COLORS:
WHITE, TURNER OAK, WINCHESTER, GOLDEN OAK, DARK WALNUT, SWAMP OAK, DARKANTHRACITE, WOOD-LIKE ANTHRACITE
ARE AVAILABLE IN SIZES 80N, 80E, 90N, 90E.

GLAZED EXTERIOR DOOR

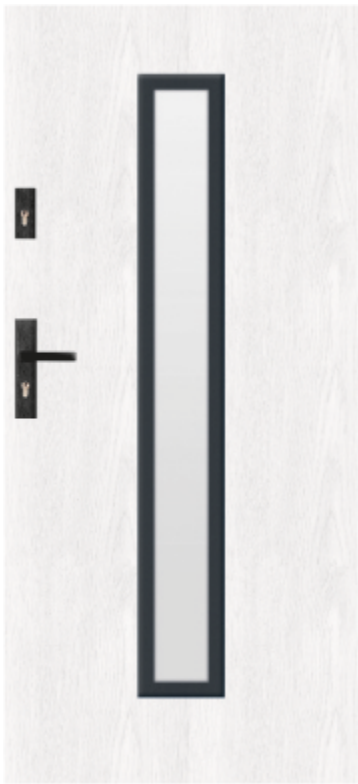

G
S34



T21
S34



T52
S34



T49
S34

STANDARD COLORS

-  WHITE
-  WOOD-LIKE WHITE
-  LIGHTGREY
-  CONCRETE
-  BLEACHED OAK
-  SONOMAOAK
-  SHEFFIELD OAK
-  WINCHESTER
-  GOLDEN OAK
-  GREY OAK
-  CORTEN
-  DARKWALNUT
-  RUSTICAL OAK
-  HORIZONTAL
-  DARKMAHOGANY
-  SWAMP OAK
-  WENGE
-  DARKANTHRACITE
-  WOOD-LIKE ANTHRACITE

EXCLUSIVE COLORS

-  TURNER OAK
-  WOOD-LIKE BLACK

*** COLORS AVAILABLE UNTIL OUT OF STOCK

STANDARD COLORS

- WHITE *
- WOOD-LIKE WHITE *
- LIGHTGREY
- CONCRETE
- BLEACHED OAK
- SONOMAOAK
- SHEFFIELD OAK
- WINCHESTER *
- GOLDEN OAK *
- GREY OAK **
- CORTEN **
- DARKWALNUT *
- RUSTICAL OAK **
- HORIZONTAL **
- DARKMAHOGANY
- SWAMP OAK *
- WENGE **
- DARKANTHRACITE *
- WOOD-LIKE ANTHRACITE *

EXCLUSIVE COLORS

- TURNER OAK *
- WOOD-LIKE BLACK
- COLORS AVAILABLE UNTIL OUT OF STOCK **

GLAZED EXTERIOR DOOR

EMBOSSING T60



GLAZING S33

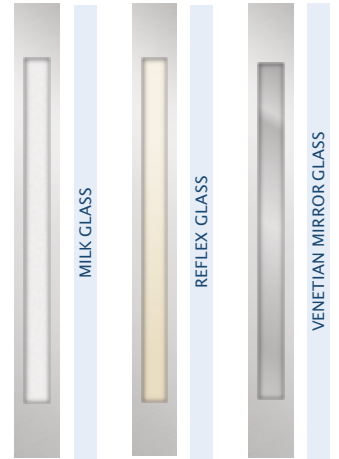

FRAMES AVAILABLE IN COLORS INOX AND BLACK

	Ud
55 STANDARD	1,6
55 PREMIUM	1,5
55 PREMIUM PLUS	1,5
72 STANDARD	1,5
72 PREMIUM	1,3
72 PREMIUM PLUS	1,2
72 PREMIUM H PLUS	1,2
85 STANDARD	1,3
85 PREMIUM	1,3
85 PREMIUM PLUS	1,0
85 PREMIUM H PLUS	1,0
101 MASTER THERM	0,70

AVAILABLE SIZES:
80N, 80E, 90N, 90E, 100N, 100E

DOORS IN SIZE 100N, 100E ONLY AVAILABLE IN COLORS MARKED WITH *

DOORS 85 MM THICK ARE MADE IN THE FOLLOWING COLORS:
WHITE, TURNER OAK, WINCHESTER, GOLDEN OAK, DARK WALNUT, SWAMP OAK, DARKANTHRACITE, WOOD-LIKE ANTHRACITE ARE AVAILABLE IN SIZES 80N, 80E, 90N, 90E.

GLAZED EXTERIOR DOOR



G
S33



T21
S33















T60
S33



T61
S33

STANDARD COLORS

-  * WHITE
-  WOOD-LIKE WHITE
-  LIGHTGREY
-  CONCRETE
-  BLEACHED OAK
-  SONOMAOAK
-  SHEFFIELD OAK
-  * WINCHESTER
-  * GOLDEN OAK
-  ** GREY OAK
-  ** CORTEN
-  * DARKWALNUT
-  ** RUSTICAL OAK
-  ** HORIZONTAL
-  DARKMAHOGANY
-  * SWAMP OAK
-  ** WENGE
-  * DARKANTHRACITE
-  * WOOD-LIKE ANTHRACITE

EXCLUSIVE COLORS

-  * TURNER OAK
-  WOOD-LIKE BLACK

** COLORS AVAILABLE UNTIL OUT OF STOCK

STANDARD COLORS

- WHITE *
- WOOD-LIKE WHITE
- LIGHTGREY
- CONCRETE
- BLEACHED OAK
- SONOMAOAK
- SHEFFIELD OAK
- WINCHESTER *
- GOLDEN OAK *
- GREY OAK ***
- CORTEN ***
- DARKWALNUT *
- RUSTICAL OAK ***
- HORIZONTAL ***
- DARKMAHOGANY
- SWAMP OAK *
- WENGE ***
- DARKANTHRACITE *
- WOOD-LIKE ANTHRACITE *

EXCLUSIVE COLORS

- TURNER OAK *
 - WOOD-LIKE BLACK
- COLORS AVAILABLE UNTIL OUT OF STOCK **

GLAZED EXTERIOR DOOR

EMBOSSING T41



GLAZING S43



FRAMES AVAILABLE IN COLORS INOX AND BLACK

	Ud
55 STANDARD	1,6
55 PREMIUM	1,5
55 PREMIUM PLUS	1,5
72 STANDARD	1,5
72 PREMIUM	1,3
72 PREMIUM PLUS	1,2
72 PREMIUM H PLUS	1,2
85 STANDARD	1,3
85 PREMIUM	1,3
85 PREMIUM PLUS	1,0
85 PREMIUM H PLUS	1,0
101 MASTER THERM	X

AVAILABLE SIZES:
80N, 80E, 90N, 90E, 100N, 100E

DOORS IN SIZE 100N, 100E ONLY AVAILABLE IN COLORS MARKED WITH *

DOORS 85 MM THICK ARE MADE IN THE FOLLOWING COLORS:
WHITE, TURNER OAK, WINCHESTER, GOLDEN OAK, DARK WALNUT, SWAMP OAK, DARKANTHRACITE, WOOD-LIKE ANTHRACITE
ARE AVAILABLE IN SIZES 80N, 80E, 90N, 90E.

GLAZED EXTERIOR DOOR



G
S43



T59
S43

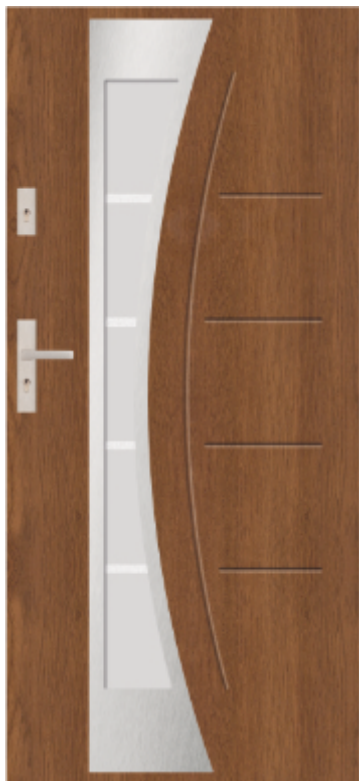

T59
S43



T41
S43

STANDARD COLORS

-  * WHITE
-  WOOD-LIKE WHITE
-  LIGHTGREY
-  CONCRETE
-  BLEACHED OAK
-  SONOMAOAK
-  SHEFFIELD OAK
-  * WINCHESTER
-  * GOLDEN OAK
-  ** GREY OAK
-  ** CORTEN
-  * DARKWALNUT
-  ** RUSTICAL OAK
-  ** HORIZONTAL
-  DARKMAHOGANY
-  * SWAMP OAK
-  ** WENGE
-  * DARKANTHRACITE
-  * WOOD-LIKE ANTHRACITE

EXCLUSIVE COLORS

-  * TURNER OAK
-  WOOD-LIKE BLACK

** COLORS AVAILABLE UNTIL OUT OF STOCK

STANDARD COLORS



EXCLUSIVE COLORS



GLAZED EXTERIOR DOOR

EMBOSSING T60

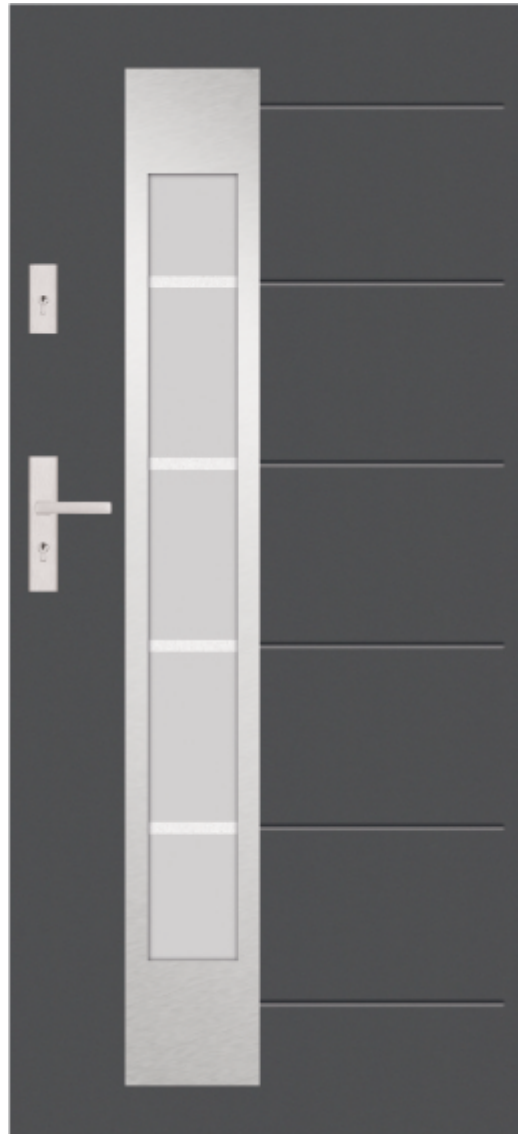

GLAZING S50

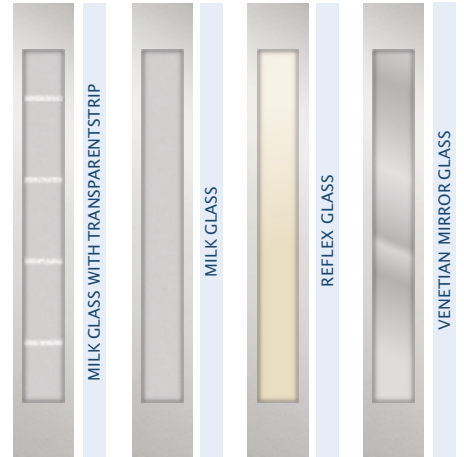

FRAMES AVAILABLE IN COLORS INOX AND BLACK

	Ud
55 STANDARD	1,6
55 PREMIUM	1,5
55 PREMIUM PLUS	1,5
72 STANDARD	1,5
72 PREMIUM	1,3
72 PREMIUM PLUS	1,2
72 PREMIUM H PLUS	1,2
85 STANDARD	X
85 PREMIUM	X
85 PREMIUM PLUS	X
85 PREMIUM H PLUS	X
101 MASTER THERM	X

AVAILABLE SIZES:
80N, 80E, 90N, 90E, 100N, 100E

DOORS IN SIZE 100N, 100E ONLY AVAILABLE IN COLORS MARKED WITH *

GLAZED EXTERIOR DOOR



G
S50

T60
S50





G
S50

T60
S50



STANDARD COLORS



















-  * WHITE
-  WOOD-LIKE WHITE
-  LIGHTGREY
-  CONCRETE
-  BLEACHED OAK
-  SONOMAOAK
-  SHEFFIELD OAK
-  * WINCHESTER
-  * GOLDEN OAK
-  ** GREY OAK
-  ** CORTEN
-  * DARKWALNUT
-  ** RUSTICAL OAK
-  ** HORIZONTAL
-  DARKMAHOGANY
-  * SWAMP OAK
-  ** WENGE
-  * DARKANTHRACITE
-  * WOOD-LIKE ANTHRACITE

EXCLUSIVE COLORS

-  * TURNER OAK
-  WOOD-LIKE BLACK

** COLORS AVAILABLE UNTIL OUT OF STOCK

STANDARD COLORS

- WHITE *
- WOOD-LIKE WHITE 
- LIGHTGREY 
- CONCRETE 
- BLEACHED OAK 
- SONOMAOAK 
- SHEFFIELD OAK 
- WINCHESTER *
- GOLDEN OAK *
- GREY OAK **
- CORTEN **
- DARKWALNUT *
- RUSTICAL OAK **
- HORIZONTAL **
- DARKMAHOGANY 
- SWAMP OAK *
- WENGE **
- DARKANTHRACITE *
- WOOD-LIKE ANTHRACITE *

EXCLUSIVE COLORS

- TURNER OAK *
 - WOOD-LIKE BLACK 
- COLORS AVAILABLE UNTIL OUT OF STOCK **

GLAZED EXTERIOR DOOR

EMBOSSING T52

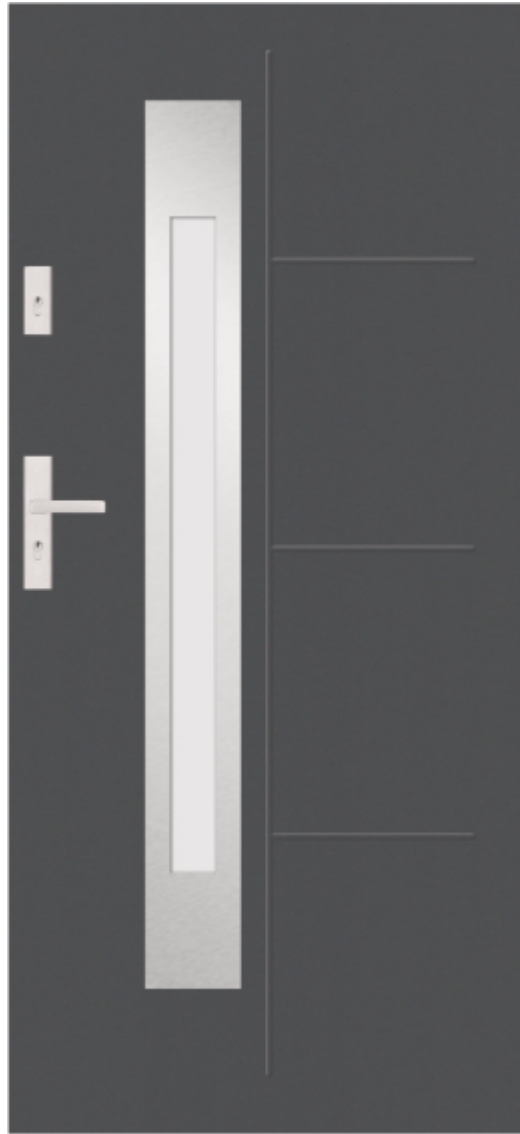

GLAZING S53

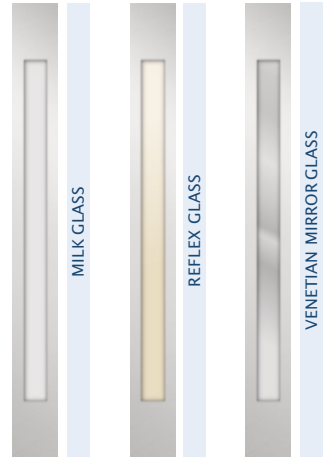

FRAMES AVAILABLE IN COLORS INOX AND BLACK

	Ud
55 STANDARD	1,6
55 PREMIUM	1,5
55 PREMIUM PLUS	1,5
72 STANDARD	1,5
72 PREMIUM	1,3
72 PREMIUM PLUS	1,2
72 PREMIUM H PLUS	1,2
85 STANDARD	X
85 PREMIUM	X
85 PREMIUM PLUS	X
85 PREMIUM H PLUS	X
101 MASTER THERM	X

AVAILABLE SIZES:
80N, 80E, 90N, 90E, 100N, 100E

DOORS IN SIZE 100N, 100E ONLY AVAILABLE IN COLORS MARKED WITH *

GLAZED EXTERIOR DOOR



G
S53



T62
S53



T52
S53



T62
S53

STANDARD COLORS

-  WHITE
-  WOOD-LIKE WHITE
-  LIGHTGREY
-  CONCRETE
-  BLEACHED OAK
-  SONOMAOAK
-  SHEFFIELD OAK
-  WINCHESTER
-  GOLDEN OAK
-  GREY OAK
-  CORTEN
-  DARKWALNUT
-  RUSTICAL OAK
-  HORIZONTAL
-  DARKMAHOGANY
-  SWAMP OAK
-  WENGE
-  DARKANTHRACITE
-  WOOD-LIKE ANTHRACITE

EXCLUSIVE COLORS

-  TURNER OAK
-  WOOD-LIKE BLACK

*** COLORS AVAILABLE UNTIL OUT OF STOCK

STANDARD COLORS



EXCLUSIVE COLORS



GLAZED EXTERIOR DOOR

EMBOSSING T53



GLAZING S60



FRAMES AVAILABLE IN COLORS INOX AND BLACK

	Ud
55 STANDARD	1,6
55 PREMIUM	1,5
55 PREMIUM PLUS	1,5
72 STANDARD	1,5
72 PREMIUM	1,3
72 PREMIUM PLUS	1,2
72 PREMIUM H PLUS	1,2
85 STANDARD	1,3
85 PREMIUM	1,3
85 PREMIUM PLUS	1,0
85 PREMIUM H PLUS	1,0
101 MASTER THERM	X

AVAILABLE SIZES:

80N, 80E, 90N, 90E, 100N, 100E

DOORS IN SIZE 100N, 100E ONLY AVAILABLE IN
COLORS MARKED WITH *

DOORS 85 MM THICK ARE MADE IN
THE FOLLOWING COLORS:

WHITE, TURNER OAK, WINCHESTER, GOLDEN OAK,
DARK WALNUT, SWAMP OAK, DARKANTHRACITE, WOOD-LIKE ANTHRACITE
ARE AVAILABLE IN SIZES 80N, 80E, 90N, 90E.

GLAZED EXTERIOR DOOR



G
S60



T53
S60



G
S60



T53
S60

STANDARD COLORS

- *  WHITE
-  WOOD-LIKE WHITE
-  LIGHTGREY
-  CONCRETE
-  BLEACHED OAK
-  SONOMAOAK
-  SHEFFIELD OAK
- *  WINCHESTER
- *  GOLDEN OAK
- **  GREY OAK
- **  CORTEN
- *  DARKWALNUT
- **  RUSTICAL OAK
- **  HORIZONTAL
-  DARKMAHOGANY
- *  SWAMP OAK
- **  WENGE
- *  DARKANTHRACITE
- *  WOOD-LIKE ANTHRACITE

EXCLUSIVE COLORS

- *  TURNER OAK
-  WOOD-LIKE BLACK

** COLORS AVAILABLE UNTIL OUT OF STOCK

STANDARD COLORS

- WHITE *
- WOOD-LIKE WHITE *
- LIGHTGREY
- CONCRETE
- BLEACHED OAK
- SONOMAOAK
- SHEFFIELD OAK
- WINCHESTER *
- GOLDEN OAK *
- GREY OAK **
- CORTEN **
- DARKWALNUT *
- RUSTICAL OAK **
- HORIZONTAL **
- DARKMAHOGANY
- SWAMP OAK *
- WENGE **
- DARKANTHRACITE *
- WOOD-LIKE ANTHRACITE *

EXCLUSIVE COLORS

- TURNER OAK *
 - WOOD-LIKE BLACK
- COLORS AVAILABLE UNTIL OUT OF STOCK **

GLAZED EXTERIOR DOOR

EMBOSSING T54



GLAZING S61



FRAMES AVAILABLE IN COLORS INOX AND BLACK

	Ud
55 STANDARD	1,6
55 PREMIUM	1,5
55 PREMIUM PLUS	1,5
72 STANDARD	1,5
72 PREMIUM	1,3
72 PREMIUM PLUS	1,2
72 PREMIUM H PLUS	1,2
85 STANDARD	1,3
85 PREMIUM	1,3
85 PREMIUM PLUS	1,0
85 PREMIUM H PLUS	1,0
101 MASTER THERM	X

AVAILABLE SIZES:
80N, 80E, 90N, 90E, 100N, 100E

DOORS IN SIZE 100N, 100E ONLY AVAILABLE IN COLORS MARKED WITH *

DOORS 85 MM THICK ARE MADE IN THE FOLLOWING COLORS:
WHITE, TURNER OAK, WINCHESTER, GOLDEN OAK, DARK WALNUT, SWAMP OAK, DARKANTHRACITE, WOOD-LIKE ANTHRACITE
ARE AVAILABLE IN SIZES 80N, 80E, 90N, 90E.

GLAZED EXTERIOR DOOR



G
S61

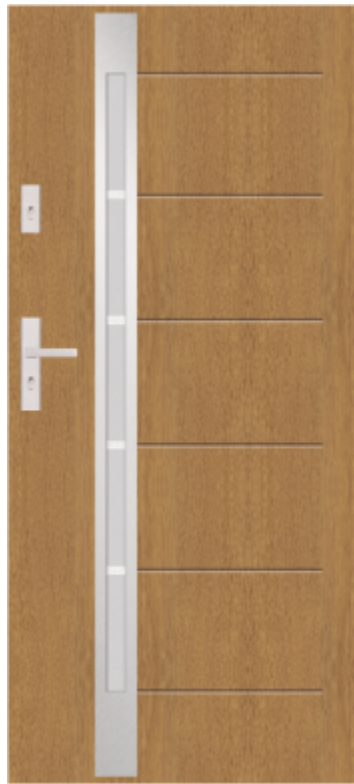

T41
S61



T54
S61



T41
S61

STANDARD COLORS

-  WHITE
-  WOOD-LIKE WHITE
-  LIGHTGREY
-  CONCRETE
-  BLEACHED OAK
-  SONOMAOAK
-  SHEFFIELD OAK
-  WINCHESTER
-  GOLDEN OAK
-  GREY OAK
-  CORTEN
-  DARKWALNUT
-  RUSTICAL OAK
-  HORIZONTAL
-  DARKMAHOGANY
-  SWAMP OAK
-  WENGE
-  DARKANTHRACITE
-  WOOD-LIKE ANTHRACITE

EXCLUSIVE COLORS

-  TURNER OAK
-  WOOD-LIKE BLACK

*** COLORS AVAILABLE UNTIL OUT OF STOCK

STANDARD COLORS



COLORS AVAILABLE UNTIL OUT OF STOCK **

GLAZED EXTERIOR DOOR

EMBOSSING T20



GLAZING



PVC FRAMES IN VENEER COLORS

	Ud
55 STANDARD	1,6
55 PREMIUM	1,5
55 PREMIUM PLUS	1,5
72 STANDARD	1,5
72 PREMIUM	1,3
72 PREMIUM PLUS	1,2
72 PREMIUM H PLUS	1,2
85 STANDARD	X
85 PREMIUM	X
85 PREMIUM PLUS	X
85 PREMIUM H PLUS	X
101 MASTER THERM	X

AVAILABLE SIZES:
80N, 80E, 90N, 90E, 100N, 100E

DOORS IN SIZE 100N, 100E ONLY AVAILABLE IN COLORS MARKED WITH *

GLAZED EXTERIOR DOOR

STANDARD COLORS



G
S16



T20
S17



*** COLORS AVAILABLE UNTIL OUT OF STOCK



T26
S16



T29
S18

STANDARD COLORS

GLAZED EXTERIOR DOOR

EMBOSSING T26|S07

GLAZING



COLORS AVAILABLE UNTIL OUT OF STOCK ******



PVC FRAMES IN VENEER COLORS

	Ud
55 STANDARD	1,6
55 PREMIUM	1,5
55 PREMIUM PLUS	1,5
72 STANDARD	1,5
72 PREMIUM	1,3
72 PREMIUM PLUS	1,2
72 PREMIUM H PLUS	1,2
85 STANDARD	X
85 PREMIUM	X
85 PREMIUM PLUS	X
85 PREMIUM H PLUS	X
101 MASTER THERM	X

AVAILABLE SIZES:
80N, 80E, 90N, 90E, 100N, 100E

DOORS IN SIZE 100N, 100E ONLY AVAILABLE IN COLORS MARKED WITH *

GLAZED EXTERIOR DOOR

STANDARD COLORS



G
S08

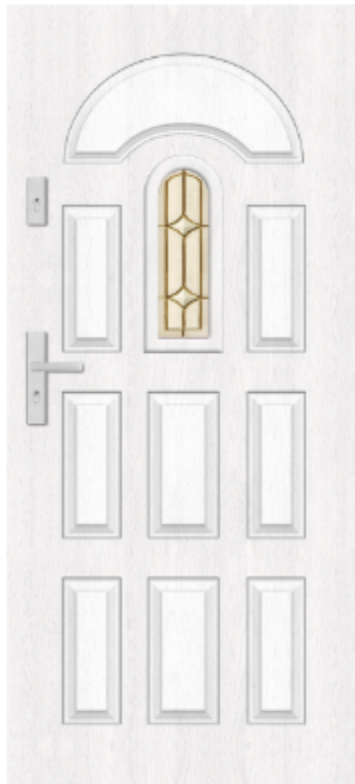

T20
S07



T26
S06



T29
S07



WHITE



WOOD-LIKE
WHITE



WINCHESTER



GOLDEN OAK



DARKWALNUT



RUSTICAL OAK



DARKMAHOGANY



SWAMP OAK



WENGE



DARKANTHRACITE

*** COLORS AVAILABLE
UNTIL OUT OF STOCK





EXTERIOR DOORS

GLAZED WITH APPLICATIONS

STANDARD COLORS

- WHITE *
- WOOD-LIKE WHITE *
- LIGHTGREY
- CONCRETE
- BLEACHED OAK
- SONOMAOAK
- SHEFFIELD OAK
- WINCHESTER *
- GOLDEN OAK *
- GREY OAK ***
- CORTEN ***
- DARKWALNUT *
- RUSTICAL OAK ***
- HORIZONTAL ***
- DARKMAHOGANY
- SWAMP OAK *
- WENGE ***
- DARKANTHRACITE *
- WOOD-LIKE ANTHRACITE *

EXCLUSIVE COLORS

- TURNER OAK *
- WOOD-LIKE BLACK
- COLORS AVAILABLE UNTIL OUT OF STOCK **

EXTERIOR GLAZED DOOR WITH APPLICATIONS

APPLICATION A46 NARROW



GLAZING S33

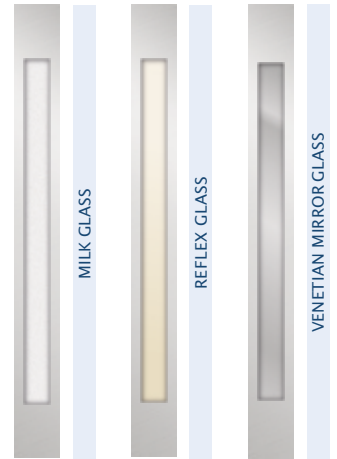

FRAMES AVAILABLE IN COLORS INOX AND BLACK

	Ud
55 STANDARD	1,6
55 PREMIUM	1,5
55 PREMIUM PLUS	1,5
72 STANDARD	1,5
72 PREMIUM	1,3
72 PREMIUM PLUS	1,2
72 PREMIUM H PLUS	1,2
85 STANDARD	1,3
85 PREMIUM	1,3
85 PREMIUM PLUS	1,0
85 PREMIUM H PLUS	1,0
101 MASTER THERM	0,70

AVAILABLE SIZES:
80N, 80E, 90N, 90E, 100N, 100E

DOORS IN SIZE 100N, 100E ONLY AVAILABLE IN COLORS MARKED WITH *

DOORS 85 MM THICK ARE MADE IN THE FOLLOWING COLORS:
WHITE, TURNER OAK, WINCHESTER, GOLDEN OAK, DARK WALNUT, SWAMP OAK, DARKANTHRACITE, WOOD-LIKE ANTHRACITE
ARE AVAILABLE IN SIZES 80N, 80E, 90N, 90E.

EXTERIOR GLAZED DOOR WITH APPLICATIONS



A46
NARROW
S33

A46
NARROW
S33





A46
NARROW
S33

A46
NARROW
S33



STANDARD COLORS



















-  WHITE
-  WOOD-LIKE WHITE
-  LIGHTGREY
-  CONCRETE
-  BLEACHED OAK
-  SONOMAOAK
-  SHEFFIELD OAK
-  WINCHESTER
-  GOLDEN OAK
-  GREY OAK
-  CORTEN
-  DARKWALNUT
-  RUSTICAL OAK
-  HORIZONTAL
-  DARKMAHOGANY
-  SWAMP OAK
-  WENGE
-  DARKANTHRACITE
-  WOOD-LIKE ANTHRACITE

EXCLUSIVE COLORS

-  TURNER OAK
-  WOOD-LIKE BLACK

*** COLORS AVAILABLE UNTIL OUT OF STOCK

STANDARD COLORS

- WHITE 
- WOOD-LIKE WHITE 
- LIGHTGREY 
- CONCRETE 
- BLEACHED OAK 
- SONOMAOAK 
- SHEFFIELD OAK 
- WINCHESTER 
- GOLDEN OAK 
- GREY OAK 
- CORTEN 
- DARKWALNUT 
- RUSTICAL OAK 
- HORIZONTAL 
- DARKMAHOGANY 
- SWAMP OAK 
- WENGE 
- DARKANTHRACITE 
- WOOD-LIKE ANTHRACITE 

EXCLUSIVE COLORS

- TURNER OAK 
 - WOOD-LIKE BLACK 
- COLORS AVAILABLE UNTIL OUT OF STOCK ******

EXTERIOR GLAZED DOOR WITH APPLICATIONS

APPLICATION A41WIDE

GLAZING S36

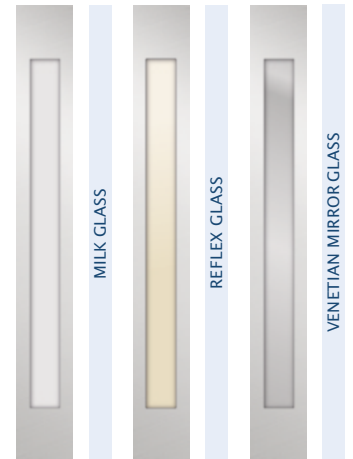

FRAMES AVAILABLE IN COLORS
INOX AND BLACK

AVAILABLE SIZES:
80N, 80E, 90N, 90E, 100N, 100E

DOORS IN SIZE 100N, 100E ONLY AVAILABLE IN
COLORS MARKED WITH *

DOORS 85 MM THICK ARE MADE IN
THE FOLLOWING COLORS:
WHITE, TURNER OAK, WINCHESTER, GOLDEN OAK,
DARK WALNUT, SWAMP OAK, DARKANTHRACITE, WOOD-LIKE ANTHRACITE
ARE AVAILABLE IN SIZES 80N, 80E, 90N, 90E.

	Ud
55 STANDARD	1,6
55 PREMIUM	1,5
55 PREMIUM PLUS	1,5
72 STANDARD	1,5
72 PREMIUM	1,3
72 PREMIUM PLUS	1,2
72 PREMIUM H PLUS	1,2
85 STANDARD	1,3
85 PREMIUM	1,3
85 PREMIUM PLUS	1,0
85 PREMIUM H PLUS	1,0
101 MASTER THERM	0,70

EXTERIOR GLAZED DOOR WITH APPLICATIONS



A41
WIDE
S36



A41
WIDE
S36



















A41
WIDE
S36



A41
WIDE
S36

STANDARD COLORS

-  * WHITE
-  WOOD-LIKE WHITE
-  LIGHTGREY
-  CONCRETE
-  BLEACHED OAK
-  SONOMAOAK
-  SHEFFIELD OAK
-  * WINCHESTER
-  * GOLDEN OAK
-  ** GREY OAK
-  ** CORTEN
-  * DARKWALNUT
-  ** RUSTICAL OAK
-  ** HORIZONTAL
-  DARKMAHOGANY
-  * SWAMP OAK
-  ** WENGE
-  * DARKANTHRACITE
-  * WOOD-LIKE ANTHRACITE

EXCLUSIVE COLORS

-  * TURNER OAK
-  WOOD-LIKE BLACK

** COLORS AVAILABLE UNTIL OUT OF STOCK

STANDARD COLORS

- WHITE *
- WOOD-LIKE WHITE *
- LIGHTGREY
- CONCRETE
- BLEACHED OAK
- SONOMAOAK
- SHEFFIELD OAK
- WINCHESTER *
- GOLDEN OAK *
- GREY OAK ***
- CORTEN ***
- DARKWALNUT *
- RUSTICAL OAK ***
- HORIZONTAL ***
- DARKMAHOGANY
- SWAMP OAK *
- WENGE ***
- DARKANTHRACITE *
- WOOD-LIKE ANTHRACITE *

EXCLUSIVE COLORS

- TURNER OAK *
 - WOOD-LIKE BLACK
- COLORS AVAILABLE UNTIL OUT OF STOCK ***

EXTERIOR GLAZED DOOR WITH APPLICATIONS

APPLICATION A53NARROW

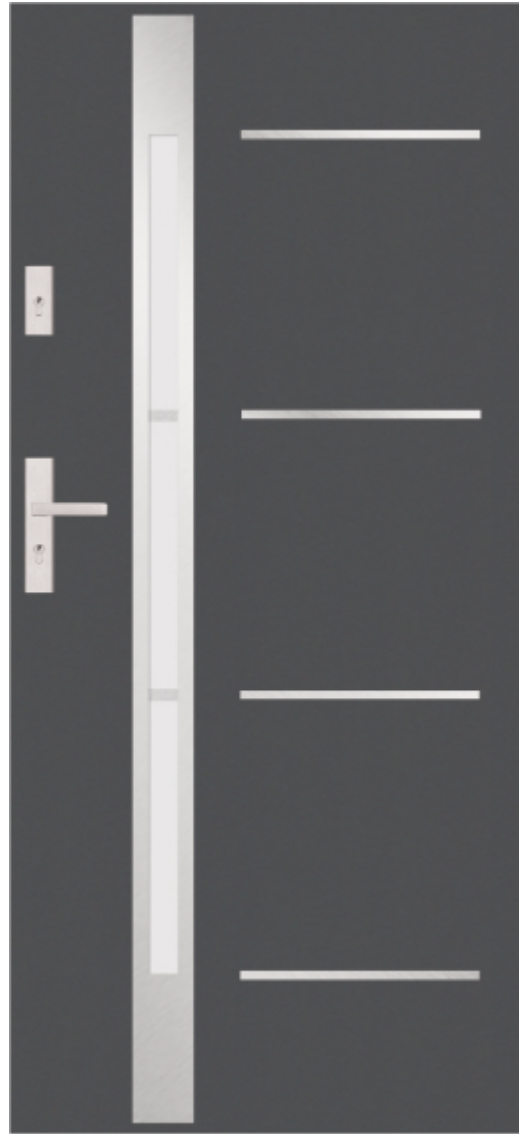

GLAZING S60



FRAMES AVAILABLE IN COLORS INOX AND BLACK

	Ud
55 STANDARD	1,6
55 PREMIUM	1,5
55 PREMIUM PLUS	1,5
72 STANDARD	1,5
72 PREMIUM	1,3
72 PREMIUM PLUS	1,2
72 PREMIUM H PLUS	1,2
85 STANDARD	1,3
85 PREMIUM	1,3
85 PREMIUM PLUS	1,0
85 PREMIUM H PLUS	1,0
101 MASTER THERM	X

AVAILABLE SIZES:
80N, 80E, 90N, 90E, 100N, 100E

DOORS IN SIZE 100N, 100E ONLY AVAILABLE IN COLORS MARKED WITH *

DOORS 85 MM THICK ARE MADE IN THE FOLLOWING COLORS:
WHITE, TURNER OAK, WINCHESTER, GOLDEN OAK, DARK WALNUT, SWAMP OAK, DARKANTHRACITE, WOOD-LIKE ANTHRACITE
ARE AVAILABLE IN SIZES 80N, 80E, 90N, 90E.

EXTERIOR GLAZED DOOR WITH APPLICATIONS



A53
NARROW
S60



A53
NARROW
S60



A53
NARROW
S60



A53
NARROW
S60

STANDARD COLORS



















-  WHITE
-  WOOD-LIKE WHITE
-  LIGHTGREY
-  CONCRETE
-  BLEACHED OAK
-  SONOMAOAK
-  SHEFFIELD OAK
-  WINCHESTER
-  GOLDEN OAK
-  GREY OAK
-  CORTEN
-  DARKWALNUT
-  RUSTICAL OAK
-  HORIZONTAL
-  DARKMAHOGANY
-  SWAMP OAK
-  WENGE
-  DARKANTHRACITE
-  WOOD-LIKE ANTHRACITE

EXCLUSIVE COLORS

-  TURNER OAK
-  WOOD-LIKE BLACK

*** COLORS AVAILABLE UNTIL OUT OF STOCK

STANDARD COLORS

- WHITE 
- WOOD-LIKE WHITE 
- LIGHTGREY 
- CONCRETE 
- BLEACHED OAK 
- SONOMAOAK 
- SHEFFIELD OAK 
- WINCHESTER 
- GOLDEN OAK 
- GREY OAK 
- CORTEN 
- DARKWALNUT 
- RUSTICAL OAK 
- HORIZONTAL 
- DARKMAHOGANY 
- SWAMP OAK 
- WENGE 
- DARKANTHRACITE 
- WOOD-LIKE ANTHRACITE 

EXCLUSIVE COLORS

- TURNER OAK 
 - WOOD-LIKE BLACK 
- COLORS AVAILABLE UNTIL OUT OF STOCK ******

EXTERIOR GLAZED DOOR WITH APPLICATIONS

APPLICATION A49 NARROW

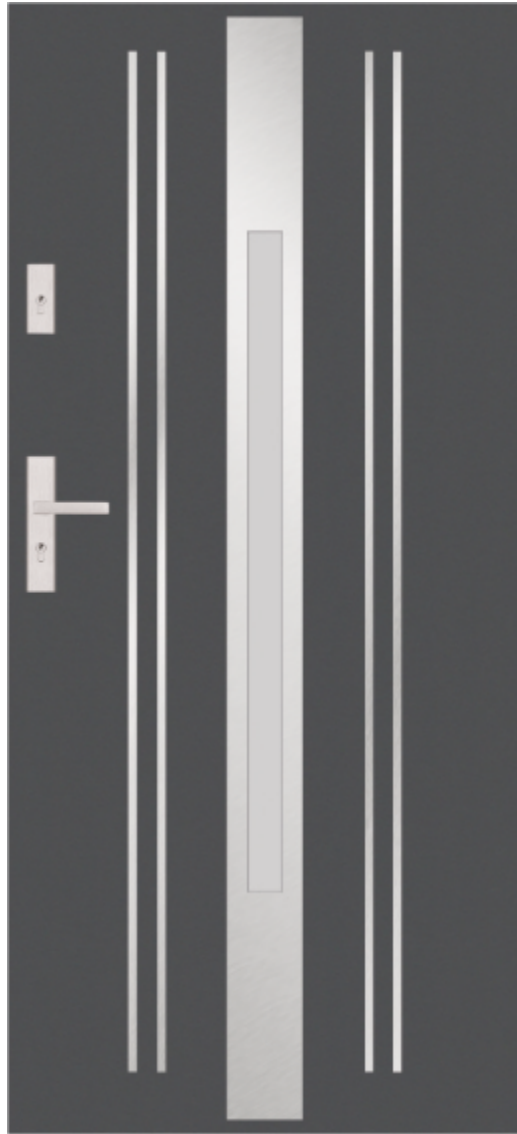

GLAZING S62

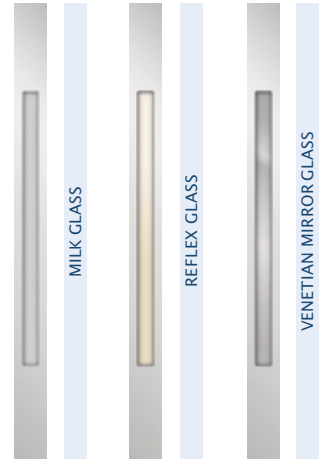

FRAMES AVAILABLE IN COLORS INOX AND BLACK

	Ud
55 STANDARD	1,6
55 PREMIUM	1,5
55 PREMIUM PLUS	1,5
72 STANDARD	1,5
72 PREMIUM	1,3
72 PREMIUM PLUS	1,2
72 PREMIUM H PLUS	1,2
85 STANDARD	1,3
85 PREMIUM	1,3
85 PREMIUM PLUS	1,0
85 PREMIUM H PLUS	1,0
101 MASTER THERM	X

AVAILABLE SIZES:
80N, 80E, 90N, 90E, 100N, 100E

DOORS IN SIZE 100N, 100E ONLY AVAILABLE IN COLORS MARKED WITH *

EXTERIOR GLAZED DOOR WITH APPLICATIONS



A49
NARROW
S62



A49
NARROW
S62



A49
NARROW
S62



A49
NARROW
S62

STANDARD COLORS

-  WHITE
-  WOOD-LIKE WHITE
-  LIGHTGREY
-  CONCRETE
-  BLEACHED OAK
-  SONOMAOAK
-  SHEFFIELD OAK
-  WINCHESTER
-  GOLDEN OAK
-  GREY OAK
-  CORTEN
-  DARKWALNUT
-  RUSTICAL OAK
-  HORIZONTAL
-  DARKMAHOGANY
-  SWAMP OAK
-  WENGE
-  DARKANTHRACITE
-  WOOD-LIKE ANTHRACITE

EXCLUSIVE COLORS

-  TURNER OAK
-  WOOD-LIKE BLACK

*** COLORS AVAILABLE UNTIL OUT OF STOCK





EXTERIOR DOORS

WITH APPLICATIONS

STANDARD COLORS

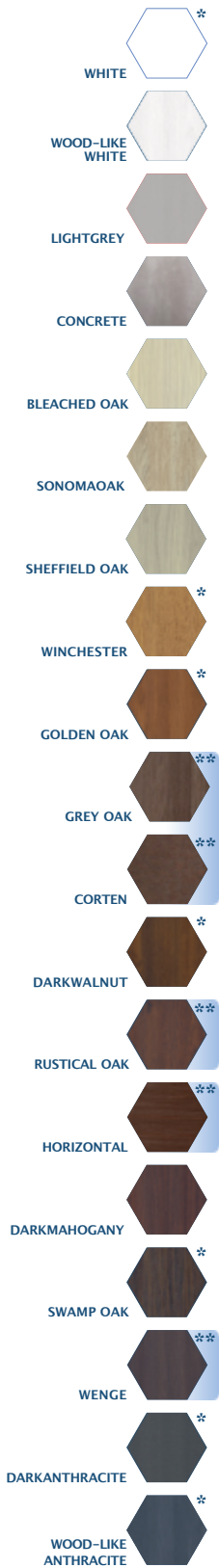

EXCLUSIVE COLORS



EXTERIOR DOORS WITH APPLICATIONS



EMBOSSING T54 APPLICATION A5

	Ud
55 STANDARD	1,4
55 PREMIUM	1,2
55 PREMIUM PLUS	1,2
72 STANDARD	1,3
72 PREMIUM	1,2
72 PREMIUM PLUS	1,0
72 PREMIUM H PLUS	1,0
85 STANDARD	1,2
85 PREMIUM	1,1
85 PREMIUM PLUS	0,91
85 PREMIUM H PLUS	0,91
101 MASTER THERM	0,63

AVAILABLE SIZES:

80N, 80E, 90N, 90E, 100N, 100E

DOORS IN SIZE 100N, 100E ONLY AVAILABLE IN

COLORS MARKED WITH *

DOORS 85 MM THICK ARE MADE IN

THE FOLLOWING COLORS:

WHITE, TURNER OAK, WINCHESTER, GOLDEN OAK,

DARK WALNUT, SWAMP OAK, DARKANTHRACITE, WOOD-LIKE ANTHRACITE

ARE AVAILABLE IN SIZES 80N, 80E, 90N, 90E.

OTHER APPLICATION MODELS, SEE PAGE 139 CATALOG

EXTERIOR DOORS WITH APPLICATIONS



T45
A22



T41
A1



T49
A7

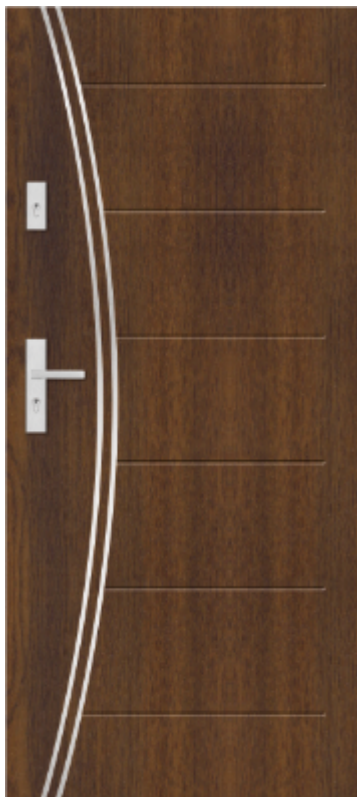

T45
A2

STANDARD COLORS

-  WHITE
-  WOOD-LIKE WHITE
-  LIGHTGREY
-  CONCRETE
-  BLEACHED OAK
-  SONOMAOAK
-  SHEFFIELD OAK
-  WINCHESTER
-  GOLDEN OAK
-  GREY OAK
-  CORTEN
-  DARKWALNUT
-  RUSTICAL OAK
-  HORIZONTAL
-  DARKMAHOGANY
-  SWAMP OAK
-  WENGE
-  DARKANTHRACITE
-  WOOD-LIKE ANTHRACITE

EXCLUSIVE COLORS

-  TURNER OAK
-  WOOD-LIKE BLACK

*** COLORS AVAILABLE UNTIL OUT OF STOCK























EXTERIOR DOORS

FULL

STANDARD COLORS

- WHITE *
- WOOD-LIKE WHITE 
- LIGHTGREY 
- CONCRETE 
- BLEACHED OAK 
- SONOMAOAK 
- SHEFFIELD OAK 
- WINCHESTER *
- GOLDEN OAK 
- GREY OAK **
- CORTEN **
- DARKWALNUT *
- RUSTICAL OAK **
- HORIZONTAL **
- DARKMAHOGANY 
- SWAMP OAK *
- WENGE **
- DARKANTHRACITE *
- WOOD-LIKE ANTHRACITE *

EXCLUSIVE COLORS

- TURNER OAK *
 - WOOD-LIKE BLACK 
- COLORS AVAILABLE UNTIL OUT OF STOCK **

EXTERIOR DOOR FULL



SMOOTH | G

	Ud
55 STANDARD	1,4
55 PREMIUM	1,2
55 PREMIUM PLUS	1,2
72 STANDARD	1,3
72 PREMIUM	1,2
72 PREMIUM PLUS	1,0
72 PREMIUM H PLUS	1,0
85 STANDARD	1,2
85 PREMIUM	1,1
85 PREMIUM PLUS	0,91
85 PREMIUM H PLUS	0,91
101 MASTER THERM	0,63

AVAILABLE SIZES:
80N, 80E, 90N, 90E, 100N, 100E

DOORS IN SIZE 100N, 100E ONLY AVAILABLE IN
COLORS MARKED WITH *

DOORS 85 MM THICK ARE MADE IN
THE FOLLOWING COLORS:
WHITE, TURNER OAK, WINCHESTER, GOLDEN OAK,
DARK WALNUT, SWAMP OAK, DARKANTHRACITE, WOOD-LIKE ANTHRACITE
ARE AVAILABLE IN SIZES 80N, 80E, 90N, 90E.

EXTERIOR DOOR FULL



T20



T21



T26



T29

STANDARD COLORS

-  * WHITE
-  WOOD-LIKE WHITE
-  LIGHTGREY
-  CONCRETE
-  BLEACHED OAK
-  SONOMAOAK
-  SHEFFIELD OAK
-  * WINCHESTER
-  * GOLDEN OAK
-  ** GREY OAK
-  ** CORTEN
-  * DARKWALNUT
-  ** RUSTICAL OAK
-  ** HORIZONTAL
-  DARKMAHOGANY
-  * SWAMP OAK
-  ** WENGE
-  * DARKANTHRACITE
-  * WOOD-LIKE ANTHRACITE

EXCLUSIVE COLORS

-  * TURNER OAK
-  WOOD-LIKE BLACK
-  ** COLORS AVAILABLE UNTIL OUT OF STOCK

STANDARD COLORS

- WHITE *
- WOOD-LIKE WHITE
- LIGHTGREY
- CONCRETE
- BLEACHED OAK
- SONOMAOAK
- SHEFFIELD OAK
- WINCHESTER *
- GOLDEN OAK *
- GREY OAK ***
- CORTEN ***
- DARKWALNUT *
- RUSTICAL OAK ***
- HORIZONTAL ***
- DARKMAHOGANY
- SWAMP OAK *
- WENGE ***
- DARKANTHRACITE *
- WOOD-LIKE ANTHRACITE *

EXCLUSIVE COLORS

- TURNER OAK *
 - WOOD-LIKE BLACK
- COLORS AVAILABLE UNTIL OUT OF STOCK ***

EXTERIOR DOOR FULL



EMBOSSING T41

	Ud
55 STANDARD	1,4
55 PREMIUM	1,2
55 PREMIUM PLUS	1,2
72 STANDARD	1,3
72 PREMIUM	1,2
72 PREMIUM PLUS	1,0
72 PREMIUM H PLUS	1,0
85 STANDARD	1,2
85 PREMIUM	1,1
85 PREMIUM PLUS	0,91
85 PREMIUM H PLUS	0,91
101 MASTER THERM	0,63

AVAILABLE SIZES:
80N, 80E, 90N, 90E, 100N, 100E

DOORS IN SIZE 100N, 100E ONLY AVAILABLE IN COLORS MARKED WITH *

DOORS 85 MM THICK ARE MADE IN THE FOLLOWING COLORS:
WHITE, TURNER OAK, WINCHESTER, GOLDEN OAK, DARK WALNUT, SWAMP OAK, DARKANTHRACITE, WOOD-LIKE ANTHRACITE ARE AVAILABLE IN SIZES 80N, 80E, 90N, 90E.

EXTERIOR DOOR FULL



T42



T43













T44



T45

STANDARD COLORS

-  * WHITE
-  WOOD-LIKE WHITE
-  LIGHTGREY
-  CONCRETE
-  BLEACHED OAK
-  SONOMAOAK
-  SHEFFIELD OAK
-  * WINCHESTER
-  * GOLDEN OAK
-  ** GREY OAK
-  ** CORTEN
-  * DARKWALNUT
-  ** RUSTICAL OAK
-  ** HORIZONTAL
-  DARKMAHOGANY
-  * SWAMP OAK
-  ** WENGE
-  * DARKANTHRACITE
-  * WOOD-LIKE ANTHRACITE

EXCLUSIVE COLORS

-  * TURNER OAK
-  WOOD-LIKE BLACK

** COLORS AVAILABLE UNTIL OUT OF STOCK

STANDARD COLORS

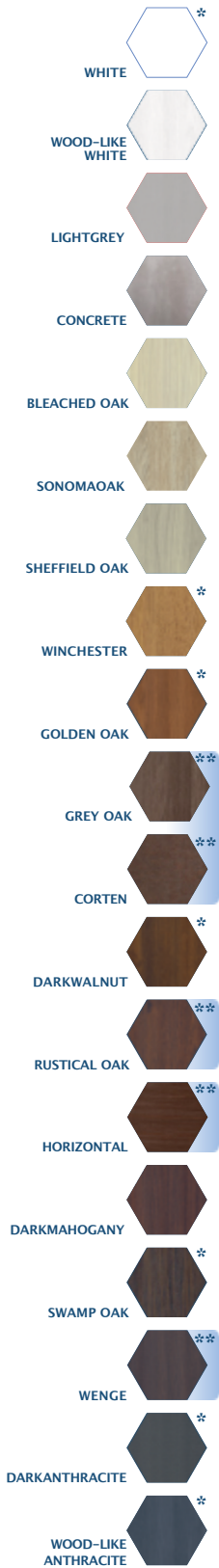

EXCLUSIVE COLORS



EXTERIOR DOOR FULL



EMBOSSING T46

	Ud
55 STANDARD	1,4
55 PREMIUM	1,2
55 PREMIUM PLUS	1,2
72 STANDARD	1,3
72 PREMIUM	1,2
72 PREMIUM PLUS	1,0
72 PREMIUM H PLUS	1,0
85 STANDARD	1,2
85 PREMIUM	1,1
85 PREMIUM PLUS	0,91
85 PREMIUM H PLUS	0,91
101 MASTER THERM	0,63

AVAILABLE SIZES:

80N, 80E, 90N, 90E, 100N, 100E

DOORS IN SIZE 100N, 100E ONLY AVAILABLE IN COLORS MARKED WITH *

DOORS 85 MM THICK ARE MADE IN THE FOLLOWING COLORS:

WHITE, TURNER OAK, WINCHESTER, GOLDEN OAK, DARK WALNUT, SWAMP OAK, DARKANTHRACITE, WOOD-LIKE ANTHRACITE ARE AVAILABLE IN SIZES 80N, 80E, 90N, 90E.

EXTERIOR DOOR FULL

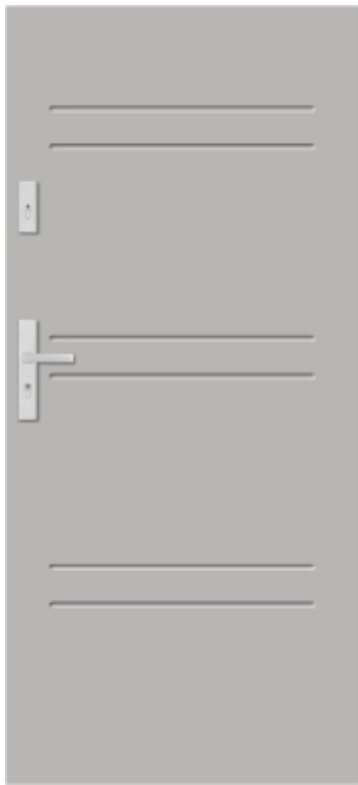

T47



T48













T49



T50

STANDARD COLORS

-  WHITE
-  WOOD-LIKE WHITE
-  LIGHTGREY
-  CONCRETE
-  BLEACHED OAK
-  SONOMAOAK
-  SHEFFIELD OAK
-  WINCHESTER
-  GOLDEN OAK
-  GREY OAK
-  CORTEN
-  DARKWALNUT
-  RUSTICAL OAK
-  HORIZONTAL
-  DARKMAHOGANY
-  SWAMP OAK
-  WENGE
-  DARKANTHRACITE
-  WOOD-LIKE ANTHRACITE

EXCLUSIVE COLORS

-  TURNER OAK
-  WOOD-LIKE BLACK

****** COLORS AVAILABLE UNTIL OUT OF STOCK

STANDARD COLORS

- WHITE *
- WOOD-LIKE WHITE
- LIGHTGREY
- CONCRETE
- BLEACHED OAK
- SONMAOAK
- SHEFFIELD OAK
- WINCHESTER *
- GOLDEN OAK *
- GREY OAK ***
- CORTEN ***
- DARKWALNUT *
- RUSTICAL OAK ***
- HORIZONTAL ***
- DARKMAHOAGANY
- SWAMP OAK *
- WENGE ***
- DARKANTHRACITE *
- WOOD-LIKE ANTHRACITE *

EXCLUSIVE COLORS

- TURNER OAK *
 - WOOD-LIKE BLACK
- COLORS AVAILABLE UNTIL OUT OF STOCK ***

EXTERIOR DOOR FULL



EMBOSSING T51

	Ud
55 STANDARD	1,4
55 PREMIUM	1,2
55 PREMIUM PLUS	1,2
72 STANDARD	1,3
72 PREMIUM	1,2
72 PREMIUM PLUS	1,0
72 PREMIUM H PLUS	1,0
85 STANDARD	1,2
85 PREMIUM	1,1
85 PREMIUM PLUS	0,91
85 PREMIUM H PLUS	0,91
101 MASTER THERM	0,63

AVAILABLE SIZES:
80N, 80E, 90N, 90E, 100N, 100E

DOORS IN SIZE 100N, 100E ONLY AVAILABLE IN COLORS MARKED WITH *

DOORS 85 MM THICK ARE MADE IN THE FOLLOWING COLORS:
WHITE, TURNER OAK, WINCHESTER, GOLDEN OAK, DARK WALNUT, SWAMP OAK, DARKANTHRACITE, WOOD-LIKE ANTHRACITE ARE AVAILABLE IN SIZES 80N, 80E, 90N, 90E.

EXTERIOR DOOR FULL



T52



T53







T54



T58

STANDARD COLORS

-  WHITE
-  WOOD-LIKE WHITE
-  LIGHTGREY
-  CONCRETE
-  BLEACHED OAK
-  SONOMAOAK
-  SHEFFIELD OAK
-  WINCHESTER
-  GOLDEN OAK
-  GREY OAK
-  CORTEN
-  DARKWALNUT
-  RUSTICAL OAK
-  HORIZONTAL
-  DARKMAHOGANY
-  SWAMP OAK
-  WENGE
-  DARKANTHRACITE
-  WOOD-LIKE ANTHRACITE

EXCLUSIVE COLORS

-  TURNER OAK
-  WOOD-LIKE BLACK

*** COLORS AVAILABLE UNTIL OUT OF STOCK

STANDARD COLORS

- WHITE *
- WOOD-LIKE WHITE *
- LIGHTGREY *
- CONCRETE *
- BLEACHED OAK *
- SONOMAOAK *
- SHEFFIELD OAK *
- WINCHESTER *
- GOLDEN OAK *
- GREY OAK **
- CORTEN **
- DARKWALNUT *
- RUSTICAL OAK **
- HORIZONTAL **
- DARKMAHOAGANY *
- SWAMP OAK *
- WENGE **
- DARKANTHRACITE *
- WOOD-LIKE ANTHRACITE *

EXCLUSIVE COLORS

- TURNER OAK *
 - WOOD-LIKE BLACK *
- COLORS AVAILABLE UNTIL OUT OF STOCK **

EXTERIOR DOOR FULL

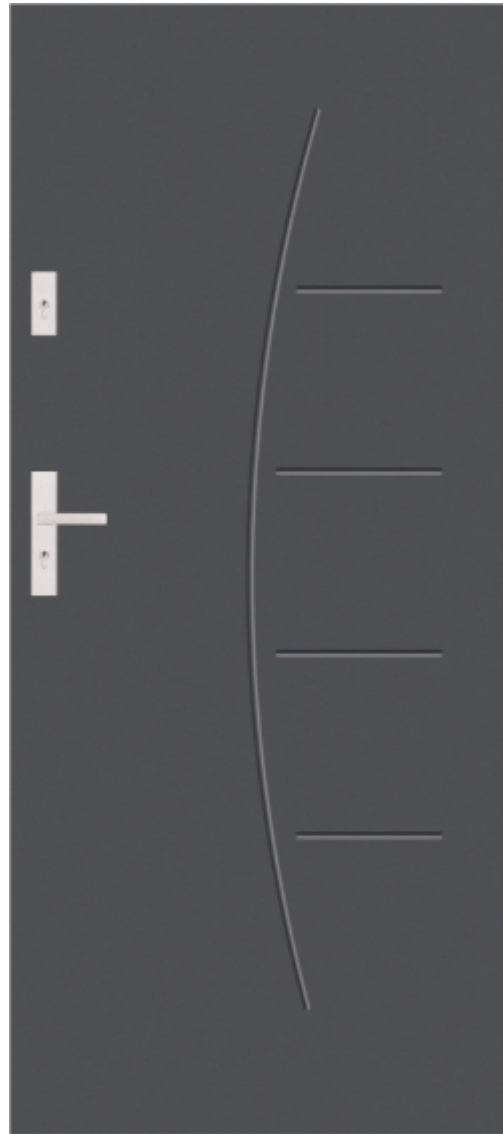

EMBOSSING T59

	Ud
55 STANDARD	1,4
55 PREMIUM	1,2
55 PREMIUM PLUS	1,2
72 STANDARD	1,3
72 PREMIUM	1,2
72 PREMIUM PLUS	1,0
72 PREMIUM H PLUS	1,0
85 STANDARD	1,2
85 PREMIUM	1,1
85 PREMIUM PLUS	0,91
85 PREMIUM H PLUS	0,91
101 MASTER THERM	0,63

AVAILABLE SIZES:
80N, 80E, 90N, 90E, 100N, 100E

DOORS IN SIZE 100N, 100E ONLY AVAILABLE IN COLORS MARKED WITH *

DOORS 85 MM THICK ARE MADE IN THE FOLLOWING COLORS:
WHITE, TURNER OAK, WINCHESTER, GOLDEN OAK, DARK WALNUT, SWAMP OAK, DARKANTHRACITE, WOOD-LIKE ANTHRACITE ARE AVAILABLE IN SIZES 80N, 80E, 90N, 90E.

EXTERIOR DOOR FULL



T60



T61



T62



T63

STANDARD COLORS

-  WHITE
-  WOOD-LIKE WHITE
-  LIGHTGREY
-  CONCRETE
-  BLEACHED OAK
-  SONOMAOAK
-  SHEFFIELD OAK
-  WINCHESTER
-  GOLDEN OAK
-  GREY OAK
-  CORTEN
-  DARKWALNUT
-  RUSTICAL OAK
-  HORIZONTAL
-  DARKMAHOGANY
-  SWAMP OAK
-  WENGE
-  DARKANTHRACITE
-  WOOD-LIKE ANTHRACITE

EXCLUSIVE COLORS

-  TURNER OAK
-  WOOD-LIKE BLACK

*** COLORS AVAILABLE UNTIL OUT OF STOCK



DOUBLE-LEAF EXTERIOR DOORS



STANDARD COLORS



EXCLUSIVE COLORS



EXTERNAL DOUBLE-LEAF DOORS | CONFIGURATION EXAMPLES

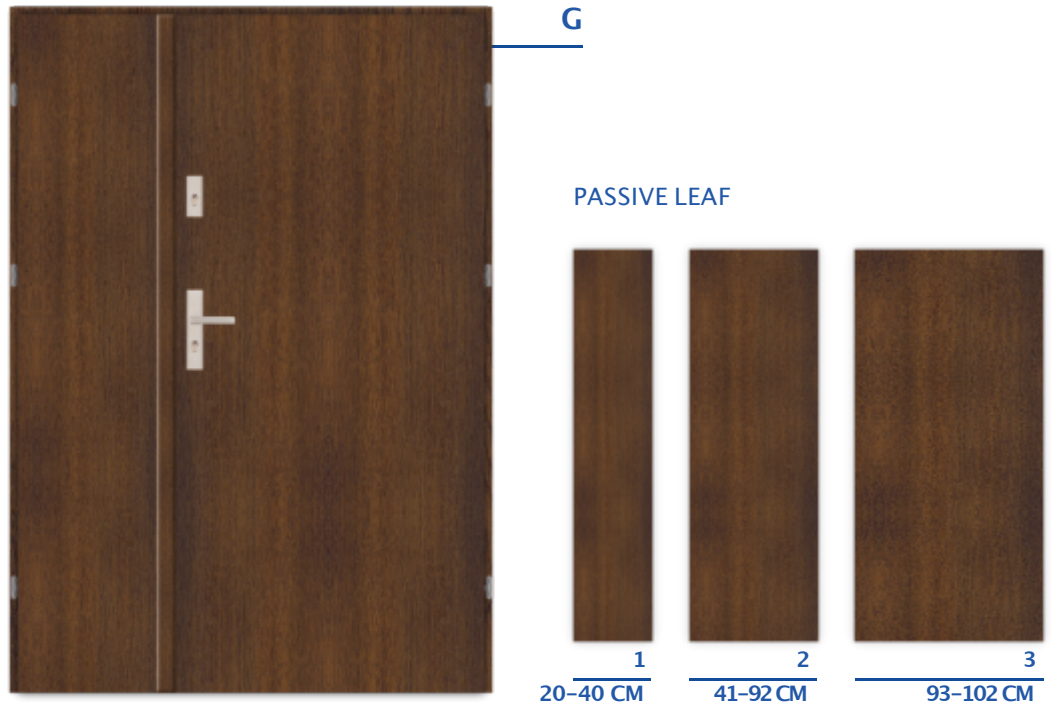

EMBOSSING AND GLAZING ARE AVAILABLE FOR THE PASSIVE LEAF WITH A MINIMUM WIDTH OF 350MM

METHOD OF VALUATION OF THE SET:

ACTIVE LEAF -PRICE ACC. TO PRICE LIST OF SINGLE-LEAF DOORS

NOTE: WHEN CHOOSING A DOUBLE-LEAF DOOR IN CLASS RC2, AN EXTRA CHARGE OF PLN 60.00 NET SHOULD BE ADDED TO THE PRICE OF THE ACTIVE LEAF

+PASSIVE LEAF

+ADDITIONAL ACCESSORIES, RAIL HANDLE, TRANSOM, WINDOWS AND APPLICATIONS FOR EACH PASSIVE LEAF

THE METHOD OF CALCULATING THE WIDTH OF THE PASSIVE LEAF:

THE WIDTH OF THE PASSIVE LEAF IS CALCULATED BY SUBTRACTING THE WIDTH OF THE MOUNTING HOLE OF THE ACTIVE DOOR FROM THE WIDTH OF THE OPENING IN THE WALL AND 9 MM FOR THE COVER STRIP LOCATED BETWEEN THE ACTIVE AND THE PASSIVE LEAF.

EXAMPLE:

OPENING IN WALL 1400MM

-(MINUS) 1021MM | WIDTH OF MOUNTING HOLE FOR DOOR 55 MM THICK ON FRAME FD-25/21/BINSIZE 90E

-(MINUS) 9 MM | COVER STRIP

=370 MM | PASSIVE LEAF WIDTH

NOTE:

SUGGESTED INSTALLATION CLEARANCE GIVEN BY THE STALPRODUKT ZAMOŚĆ IS 10MM PER SIDE

EXTERNAL DOUBLE-LEAF DOORS | CONFIGURATION EXAMPLES



T43

PASSIVE LEAF

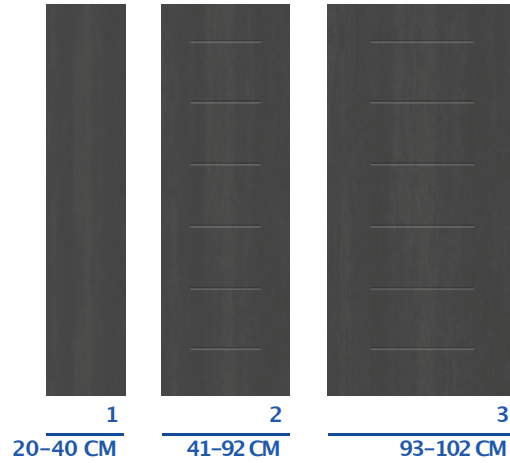

EMBOSSING AND GLAZING ARE AVAILABLE FOR THE PASSIVE LEAF WITH A MINIMUM WIDTH OF 350MM



GA21

SKRZYDŁABIERNE

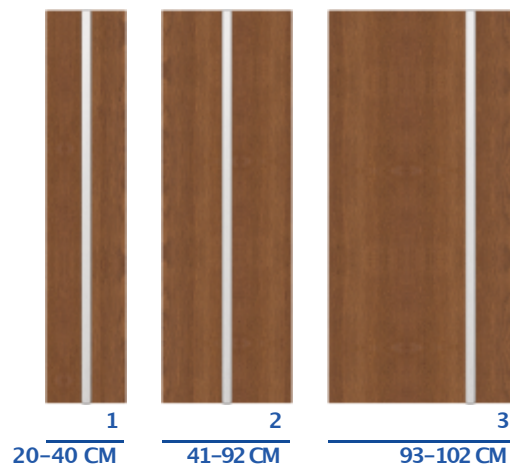

EMBOSSING AND GLAZING ARE AVAILABLE FOR THE PASSIVE LEAF WITH A MINIMUM WIDTH OF 350MM

STANDARD COLORS

- WHITE
- WOOD-LIKE WHITE
- LIGHTGREY
- CONCRETE
- BLEACHED OAK
- SONOMAOAK
- SHEFFIELD OAK
- WINCHESTER
- GOLDEN OAK
- GREY OAK
- CORTEN
- DARKWALNUT
- RUSTICAL OAK
- HORIZONTAL
- DARKMAHOGANY
- SWAMP OAK
- WENGE
- DARKANTHRACITE
- WOOD-LIKE ANTHRACITE

EXCLUSIVE COLORS

- TURNER OAK
- WOOD-LIKE BLACK

****** COLORS AVAILABLE UNTIL OUT OF STOCK

DOORS IN SIZE 100N, 100E ONLY AVAILABLE IN COLORS MARKED WITH *

STANDARD COLORS

- WHITE *
- WOOD-LIKE WHITE *
- LIGHTGREY *
- CONCRETE *
- BLEACHED OAK *
- SONOMAOAK *
- SHEFFIELD OAK *
- WINCHESTER *
- GOLDEN OAK *
- GREY OAK **
- CORTEN **
- DARKWALNUT *
- RUSTICAL OAK **
- HORIZONTAL **
- DARKMAHOGANY *
- SWAMP OAK *
- WENGE **
- DARKANTHRACITE *
- WOOD-LIKE ANTHRACITE *

EXCLUSIVE COLORS

- TURNER OAK *
 - WOOD-LIKE BLACK *
- COLORS AVAILABLE UNTIL OUT OF STOCK **

EXTERNAL DOUBLE-LEAF DOORS | CONFIGURATION EXAMPLES



T60 S33

PASSIVE LEAF

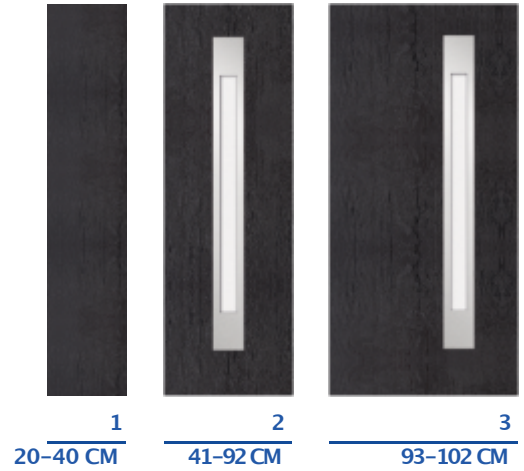

EMBOSSING AND GLAZING ARE AVAILABLE FOR THE PASSIVE LEAF WITH A MINIMUM WIDTH OF 350MM



T41S61

PASSIVE LEAF

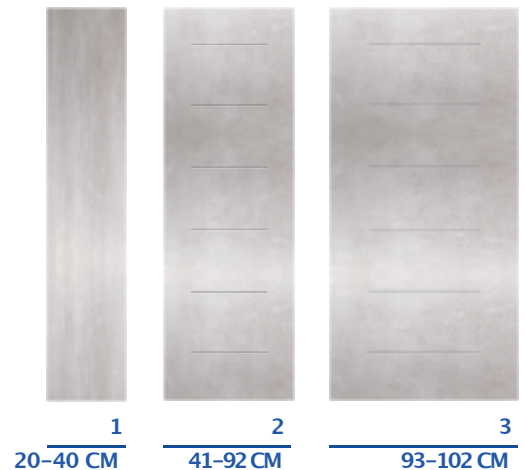

EMBOSSING AND GLAZING ARE AVAILABLE FOR THE PASSIVE LEAF WITH A MINIMUM WIDTH OF 350MM

DOORS IN SIZE 100N, 100E ONLY AVAILABLE IN COLORS MARKED WITH *

EXTERIOR DOORS WITH TRANSOMS



COLORS AVAILABLE FOR ALUMINUM TRANSOMS FRAMES AND PROFILES FOR DOOR 85 AND 72 MM THICK

-  WINCHESTER
-  GOLDEN OAK
-  DARK WALNUT
-  SWAMPOAK
-  DARK ANTHRACITE
-  WOOD-LIKE ANTHRACITE
-  WHITE RAL 9016
-  BLACK RAL 9005

OPTIONS FOR MANUFACTURING

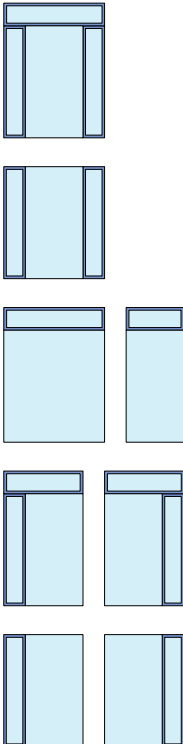

EXTERIOR DOOR WITH TRANSOM



T60 | rail handle

A11 | rail handle



EXTERIOR DOOR WITH TRANSOM



G S33

T47



COLORS AVAILABLE FOR ALUMINUM TRANSOMS FRAMES AND PROFILES FOR DOOR 55 MM THICK

GOLDEN OAK



DARKWALNUT



SWAMPOAK



DARKANTHRACITE

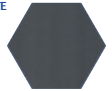

WHITE
RAL 9016



BLACK
RAL9005



OPTIONS FOR MANUFACTURING

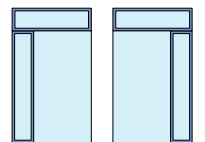
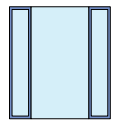
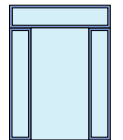



ANTI-BURGLARY DOORS



STRUCTURE

DOOR STRUCTURE



SPARK 2 | FIRE PROTECTION -INTERIOR

ACOUSTIC INSULATION CLASS



55 MM THICK LEAF WITH A TRIANGULAR ABUTMENT, WHICH CONSTRUCTION IS BASED ON A FULL WOODEN FRAME, MADE OF GALVANIZED LAMINATED METAL SHEET 0.6 MM THICK, FITTED WITH FIRE PROTECTING AND SOUND INSULATING FILLING BASED ON MINERAL WOOL, EQUIPPED WITH TWO GASKETS

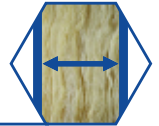

THREE ANTI-BRAKEIN PINS ON DOOR HINGE SIDE



THREE THREE-PIECE HINGES Z5, INCLUDING ONE SELF-CLOSING

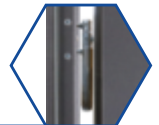

THREE-POINT LOCK CONSISTING OF A FIVE-BOLT MAIN LOCK AND TWO THREE-BOLT SECONDARY LOCKS



THREE-BOLT TOP LOCK



GALVANIZED STEEL FRAME 1.5MM THICK, LAMINATED IN THE LEAF COLOR, EQUIPPED WITH GASKET



STEEL THRESHOLD WITH GASKET

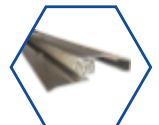

AXA ROYAL FLEX HANDLE



INSERT AND KNOB-INSERT WITH ONE KEY SYSTEM APPROVED IN CLASS B



FRAME MODELS AVAILABLE

STANDARD



FD-25/12



FD-25/21/B

EXTRA CHARGE



FD-25/12+COVER



FD-25/12+PORTAL



CUSTOM
DIMENSION
DOOR



Rw = 37 dB

ACOUSTIC INSULATION CLASS



RC 2



SMOKE STOPPER
Sa, S200



EI 30

SPARK 1 | FIRE PROTECTION -INTERIOR

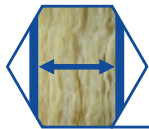

55MM THICK LEAF WITH TRIANGULAR ABUTMENT, WHICH CONSTRUCTION IS BASED ON A FULL WOODEN FRAME, MADE OF GALVANIZED LAMINATED METAL SHEET 0.6 MM THICK, FITTED WITH FIRE PROTECTING AND SOUND INSULATING FILLING BASED ON MINERAL WOOL, EQUIPPED WITH TWO GASKETS



THREE ANTI-BRAKEIN PINS ON DOOR HINGE SIDE

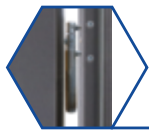

THREE THREE-PIECE HINGES Z5, INCLUDING ONE SELF-CLOSING



FIVE-BOLT MAIN LOCK



THREE-BOLT TOP LOCK



STEEL FRAME MADE OF GALVANIZED METAL SHEET 1.5MM THICK, LAMINATED IN THE LEAF COLOR, EQUIPPED WITH GASKET

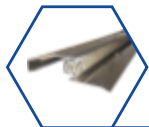

STEEL THRESHOLD WITH GASKET



AXA ROYAL FLEX HANDLE



APPROVED IN CLASS B INSERT AND KNOB-INSERT WITH ONE KEY SYSTEM



FRAME MODELS AVAILABLE

STANDARD



FD-25/12



FD-25/21/B

EXTRA CHARGE



FD-25/12+ COVER



FD-25/12+PORTAL

DOOR STRUCTURE



AMADEO | ACOUSTIC

ACOUSTIC INSULATION CLASS



55 MM THICK LEAF WITH A TRIANGULAR ABUTMENT, WHICH CONSTRUCTION IS BASED ON A FULL WOODEN FRAME, MADE OF GALVANIZED LAMINATED METALSHEET 1.0 MM THICK, FITTED WITH SOUND INSULATING FILLING BASED ON MINERAL WOOL, EQUIPPED WITH GASKET

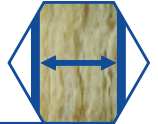

THREE ANTI-BRAKEIN PINS ON DOOR HINGE SIDE



THREE THREE-PIECE HINGES Z5

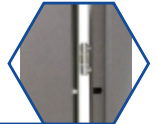

THREE-POINT LOCK CONSISTING OF A FIVE-BOLT MAIN LOCK THREE-BOLT LOWER LOCK AND VERTICAL BOLT

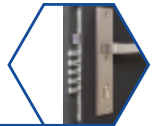

VERTICAL BOLT

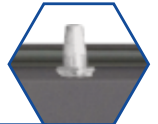

THREE-BOLT TOP LOCK



STEEL FRAME MADE OF GALVANIZED METAL SHEET 1.5MM THICK, LAMINATED IN THE LEAF COLOR, FITTED WITH A GASKET

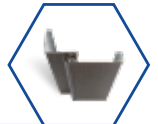

STEEL THRESHOLD WITH GASKET

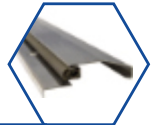

HANDLE STP-OW



INSERT AND KNOB-INSERT WITH ONE KEY SYSTEM APPROVED IN CLASS B



FRAME MODELS AVAILABLE

STANDARD



FD-25/12



FD-25/21/B



FD-25/21/C

EXTRA CHARGE



FD-25/12+ COVER



FD-25/12+PORTAL



CUSTOM DIMENSION DOOR



ACOUSTIC INSULATION CLASS

Rw = 43 dB



RC 3



Ud od 1,6 W/(m²*K)

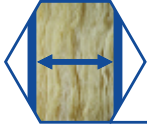

55MM THICK LEAF WITH TRIANGULAR ABUTMENT, WHICH CONSTRUCTION IS BASED ON A FULL WOODEN FRAME, MADE OF GALVANIZED LAMINATED METAL SHEET 0.6 MM THICK, FITTED WITH SOUND INSULATING FILLING BASED ON MINERAL WOOL, EQUIPPED WITH GASKET



THREE ANTI-BRAKEIN PINS ON DOOR HINGE SIDE

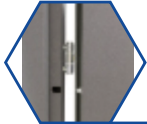

THREE THREE-PIECE HINGES Z5



THREE-POINT LOCK CONSISTING OF FIVE-BOLT MAIN LOCK, THREE-BOLT LOWER LOCK AND VERTICAL BOLT

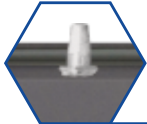

VERTICAL BOLT



THREE-BOLT TOP LOCK



STEEL FRAME MADE OF GALVANIZED METAL SHEET 1.5MM THICK, LAMINATED IN THE LEAF COLOR, EQUIPPED WITH GASKET

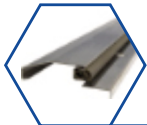

STEEL THRESHOLD WITH GASKET



HANDLE STP-OW



APPROVED IN CLASS B INSERT AND KNOB-INSERT WITH ONE KEY SYSTEM



FRAME MODELS AVAILABLE

STANDARD



FD-25/12



FD-25/21/B



FD-25/21/C

EXTRA CHARGE



FD-25/12+ COVER



FD-25/12+PORTAL

DOOR STRUCTURE



VERDI | ACOUSTIC

ACOUSTIC INSULATION CLASS



55 MM THICK LEAF WITH A TRIANGULAR ABUTMENT, WHICH CONSTRUCTION IS BASED ON A FULL WOODEN FRAME, MADE OF GALVANIZED LAMINATED METAL SHEET 0.6 MM THICK, FITTED WITH SOUND INSULATING FILLING BASED ON MINERAL WOOL, EQUIPPED WITH GASKET

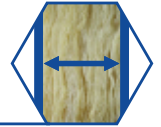

THREE ANTI-BRAKEIN PINS ON DOOR HINGE SIDE



THREE THREE-PIECE HINGES Z5



LOCK HOOKS WITH ADJUSTABLE CLAMP



THREE-BOLT MAIN LOCK



THREE-BOLT TOP LOCK



STEEL FRAME MADE OF GALVANIZED METAL SHEET 1.2MM THICK, LAMINATED IN THE LEAF COLOR, FITTED WITH A GASKET



STEEL THRESHOLD WITH GASKET

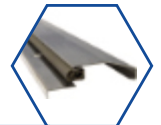

HANDLE STP-H/K2



INSERT AND KNOB-INSERT WITH ONE KEY SYSTEM APPROVED IN CLASS B



FRAME MODELS AVAILABLE

STANDARD



FD-25/12



FD-25/21/B



FD-25/21/C

EXTRA CHARGE



FD-25/12+ COVER



FD-25/12+PORTAL



CUSTOM DIMENSION DOOR



ACOUSTIC INSULATION CLASS

Rw = 33 dB



RC 4



Ud od 1,4 W/(m²*K)

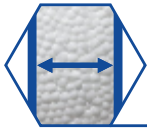

55 MM THICK LEAF WITH TRIANGULAR ABUTMENT, MADE OF GALVANIZED LAMINATED METAL SHEET 1-1.2 MM THICK, FILLED WITH FOAMED POLYSTYRENE, EQUIPPED WITH GASKET



SIX ANTI-BRAKEIN PINS ON DOOR HINGE SIDE



THREE THREE-PIECE HINGES Z5



THREE-POINT LOCK CONSISTING OF FIVE-BOLT MAIN LOCK, THREE-BOLT LOWER LOCK AND VERTICAL BOLT

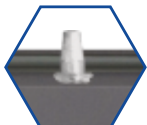

VERTICAL BOLT



THREE-BOLT TOP LOCK



STEEL FRAME MADE OF GALVANIZED METAL SHEET 1.5MM THICK, LAMINATED IN THE LEAF COLOR, EQUIPPED WITH GASKET

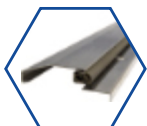

STEEL THRESHOLD WITH GASKET



AXA TORONTO FLEX HANDLE



APPROVED IN CLASS C INSERT AND KNOB-INSERT WITH ONE KEY SYSTEM



FRAME MODELS AVAILABLE

STANDARD



FD-25/12



FD-25/21/B



FD-25/21/C

EXTRA CHARGE



FD-25/12+ COVER



FD-25/12+PORTAL

DOOR STRUCTURE



ACOUSTIC INSULATION CLASS

BATORY 47



47MM THICK LEAF WITH TRIANGULAR ABUTMENT, MADE OF GALVANIZED LAMINATED METAL SHEET 1.2MM THICK, FILLED WITH FOAMED POLYSTYRENE, EQUIPPED WITH GASKET

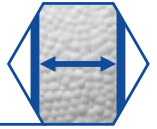

SIX ANTI-BRAKEIN PINS ON DOOR HINGE SIDE



THREE THREE-PIECE HINGES Z5



THREE-POINT LOCK CONSISTING OF A FIVE-BOLT MAIN LOCK THREE-BOLT LOWER LOCK AND VERTICAL BOLT

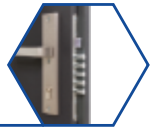

VERTICAL BOLT

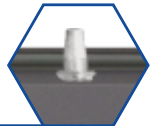

THREE-BOLT TOP LOCK



STEEL FRAME MADE OF GALVANIZED METAL SHEET 1.5MM THICK, LAMINATED IN THE LEAF COLOR



STEEL THRESHOLD WITH GASKET

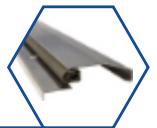

AXA TORONTO FLEX HANDLE



INSERT AND KNOB-INSERT WITH ONE KEY SYSTEM APPROVED IN CLASS C



FRAME MODELS AVAILABLE

STANDARD



FD-25/1/U



FD-25/16/U

EXTRA CHARGE



FD-25/16/U+ COVER



FD-25/16/U+PORTAL



CUSTOM DIMENSION DOOR



Rw = 29 dB

ACOUSTIC INSULATION CLASS



RC 3

DOOR STRUCTURE

HETMAN 55



Ud od 1,4 W(m²K)

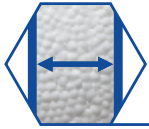

55 MM THICK LEAF WITH TRIANGULAR ABUTMENT, MADE OF GALVANIZED LAMINATED METAL SHEET 0.6 MM THICK, FILLED WITH FOAMED POLYSTYRENE, EQUIPPED WITH GASKET



THREE ANTI-BRAKEIN PINS ON DOOR HINGE SIDE

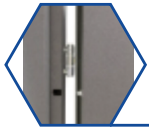

THREE THREE-PIECE HINGES Z5

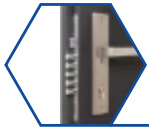

THREE-POINT LOCK CONSISTING OF FIVE-BOLT MAIN LOCK, THREE-BOLT LOWER LOCK AND VERTICAL BOLT

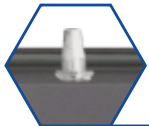

VERTICAL BOLT



THREE-BOLT TOP LOCK

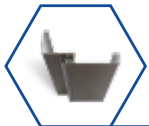

STEEL FRAME MADE OF GALVANIZED METAL SHEET 1.5MM THICK, LAMINATED IN THE LEAF COLOR, EQUIPPED WITH GASKET

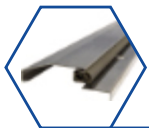

STEEL THRESHOLD WITH GASKET



HANDLE STP-OW



APPROVED IN CLASS B INSERT AND KNOB-INSERT WITH ONE KEY SYSTEM



FRAME MODELS AVAILABLE

STANDARD



FD-25/12



FD-25/21/B



FD-25/21/C

EXTRA CHARGE



FD-25/12+ COVER



FD-25/12+PORTAL



FD-25/21/P

DOOR STRUCTURE



ACOUSTIC INSULATION CLASS

HETMAN 47



47MM THICK LEAF WITH TRIANGULAR ABUTMENT, MADE OF GALVANIZED LAMINATED METAL SHEET 0.6 MM THICK, FILLED WITH FOAMED POLYSTYRENE, EQUIPPED WITH GASKET

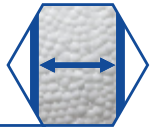

THREE ANTI-BRAKEIN PINS ON DOOR HINGE SIDE



THREE THREE-PIECE HINGES Z5

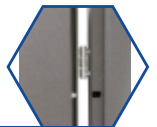

THREE-POINT LOCK CONSISTING OF A FIVE-BOLT MAIN LOCK THREE-BOLT LOWER LOCK AND VERTICAL BOLT

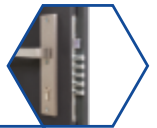

VERTICAL BOLT

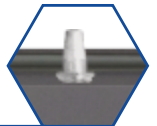

THREE-BOLT TOP LOCK



STEEL FRAME MADE OF GALVANIZED METAL SHEET 1.5MM THICK, LAMINATED IN THE LEAF COLOR

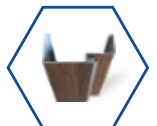

STEEL THRESHOLD WITH GASKET

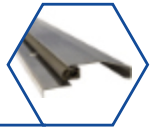

HANDLE STP-OW



INSERT AND KNOB-INSERT WITH ONE KEY SYSTEM APPROVED IN CLASS B



FRAME MODELS AVAILABLE

STANDARD



FD-25/1/U



FD-25/16/U

EXTRA CHARGE



FD-25/16/U+ COVER



FD-25/16/U+PORTAL

SENATOR E | EXTERNAL



CUSTOM DIMENSION DOOR



ACOUSTIC INSULATION CLASS

Rw = 28 dB



RC 2



Ud od 1,4 W/m²K

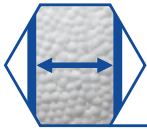

55 MM THICK LEAF WITH TRIANGULAR ABUTMENT, MADE OF GALVANIZED LAMINATED METAL SHEET 0.6 MM THICK, FILLED WITH FOAMED POLYSTYRENE, EQUIPPED WITH GASKET



THREE ANTI-BRAKEIN PINS ON DOOR HINGE SIDE



THREE THREE-PIECE HINGES Z5



THREE-BOLT MAIN LOCK



LOCK HOOKS WITH ADJUSTABLE CLAMP



THREE-BOLT TOP LOCK



STEEL FRAME MADE OF GALVANIZED METAL SHEET 1.2MM THICK, LAMINATED IN THE LEAF COLOR, EQUIPPED WITH GASKET

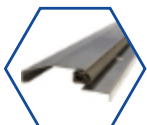

STEEL THRESHOLD WITH GASKET



HANDLE STP-H/K2



APPROVED IN CLASS B INSERT AND KNOB-INSERT WITH ONE KEY SYSTEM



FRAME MODELS AVAILABLE

STANDARD



FD-25/12



FD-25/21/B



FD-25/21/C

EXTRA CHARGE



STEEL-WOOD WITH 3D HINGE















FD-25/12+ COVER



FD-25/12+PORTAL

BRAKE IN RESISTANCE CLASSES

	TOOLS USED DURING BURGLARY	MINIMUM RESISTANCE TIME
DOOR CLASS	 RC 1 Without tools: -attempt to brake in with the shoulder or kicks, -attempt to lift or pull out the lock	  NO TESTS
	 RC 2 Attempted burglary using simple tools, e.g.: -screwdriver, pliers, wedge	  3 MINUTES
	 RC 3 Attempted burglary using other tools, e.g.: -crowbar, hammer, additional screwdriver, drill bit and mechanical drilling device	  5 MINUTES
	 RC 4 Attempted burglary using other tools, e.g.: -crowbar, hammer, additional screwdriver, drill bit and mechanical drilling device	  10 MINUTES

FIRE RESISTANCE CLASS

 EI 30 EI30 - fire resistant door marking indicates that the product provides protection against fire and high temperature for 36 minutes

SMOKE CONTROL CLASS

 SMOKE STOPPER Sa, S200 Sa S200 - doors marked with this symbol are equipped with special sealing systems to protect against the spread of smoke in the event of fire, and thus against poisoning with harmful combustion products
--



ANTI-BURGLARY DOORS

WITH EMBOSSING

STANDARD COLORS

- WHITE *
- WOOD-LIKE WHITE 
- LIGHT GREY 
- CONCRETE 
- BLEACHED OAK 
- SONOMA OAK 
- SHEFFIELD OAK 
- WINCHESTER *
- GOLDEN OAK *
- DARK WALNUT *
- RUSTICAL OAK ***
- DARK MAHOAGANY 
- SWAMP OAK *
- WENGE ***
- DARK ANTHRACITE *
- WOOD-LIKE ANTHRACITE *

EXCLUSIVE COLORS

- TURNER OAK *

COLORS AVAILABLE UNTIL OUT OF STOCK 

ANTI-BURGLARY DOORS WITH EMBOSSING

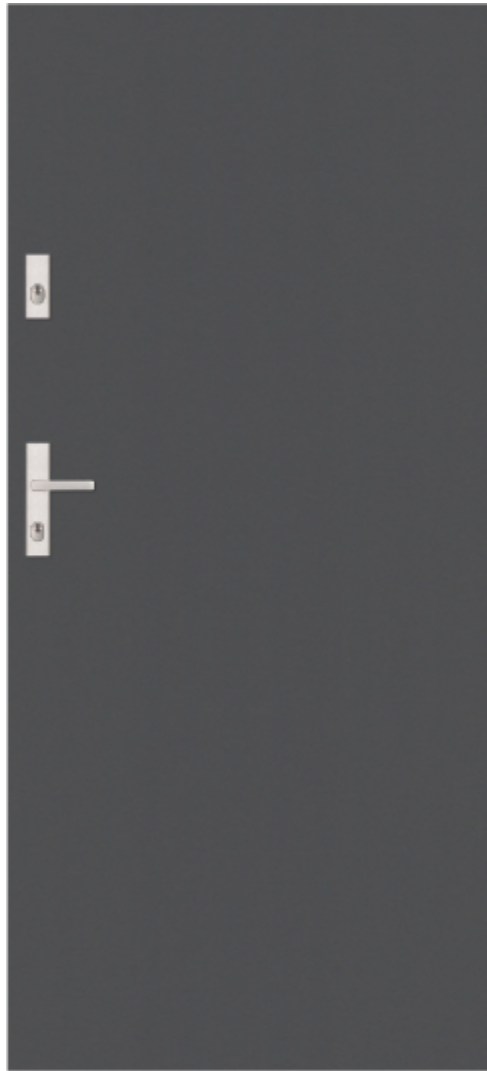

SMOOTH | G

	RC	Rw	EI	Ud
SENATOR E	2	28	X	1,4
HETMAN 47	3	29	X	X
HETMAN 55	3	29	X	1,4
BATORY 47	4	33	X	X
BATORY 55	4	33	X	1,4
VERDI	2	42	X	1,4
MOZART	3	43	X	1,6
AMADEO	3	47	X	1,6
SPARK I	2	37	30	X
SPARK II	3	42	30	X

AVAILABLE SIZES:
80N, 80E, 90N, 90E, 100N, 100E

SIZE 100N, 100E ONLY AVAILABLE IN COLORS MARKED WITH *

ANTI-BURGLARY DOORS WITH EMBOSSING

STANDARD COLORS



T01



T02

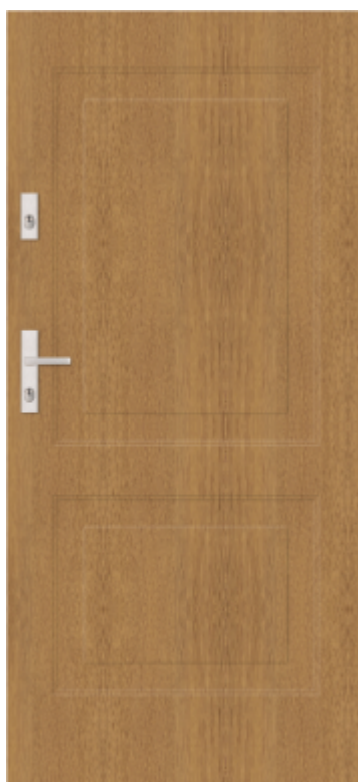

T32



T34

-  * WHITE
-  WOOD-LIKE WHITE
-  LIGHT GREY
-  CONCRETE
-  BLEACHED OAK
-  SONOMA OAK
-  SHEFFIELD OAK
-  * WINCHESTER
-  * GOLDEN OAK
-  * DARK WALNUT
-  ** RUSTICAL OAK
-  DARK MAHOGANY
-  * SWAMP OAK
-  ** WENGE
-  * DARK ANTHRACITE
-  * WOOD-LIKE ANTHRACITE

EXCLUSIVE COLORS

-  * TURNER OAK

** COLORS AVAILABLE UNTIL OUT OF STOCK

STANDARD COLORS

- WHITE *
- WOOD-LIKE WHITE 
- LIGHT GREY 
- CONCRETE 
- BLEACHED OAK 
- SONOMA OAK 
- SHEFFIELD OAK 
- WINCHESTER *
- GOLDEN OAK *
- DARK WALNUT *
- RUSTICAL OAK ***
- DARK MAHOAGANY 
- SWAMP OAK *
- WENGE ***
- DARK ANTHRACITE *
- WOOD-LIKE ANTHRACITE *

EXCLUSIVE COLORS

- TURNER OAK *

COLORS AVAILABLE UNTIL OUT OF STOCK ***

ANTI-BURGLARY DOORS WITH EMBOSSING



EMBOSSING T41

	RC	Rw	EI	Ud
SENATOR E	2	28	X	1,4
HETMAN 47	3	29	X	X
HETMAN 55	3	29	X	1,4
BATORY 47	X	X	X	X
BATORY 55	X	X	X	X
VERDI	2	42	X	1,4
MOZART	3	43	X	1,6
AMADEO	X	X	X	X
SPARK I	2	37	30	X
SPARK II	3	42	30	X

AVAILABLE SIZES:
80N, 80E, 90N, 90E, 100N, 100E

SIZE 100N, 100E ONLY AVAILABLE IN COLORS MARKED WITH *

ANTI-BURGLARY DOORS WITH EMBOSSING

STANDARD COLORS



T42



T43



T44



T45

-  * WHITE
-  WOOD-LIKE WHITE
-  LIGHT GREY
-  CONCRETE
-  BLEACHED OAK
-  SONOMA OAK
-  SHEFFIELD OAK
-  * WINCHESTER
-  * GOLDEN OAK
-  * DARK WALNUT
-  ❄️ RUSTICAL OAK
-  DARK MAHOGANY
-  * SWAMP OAK
-  ❄️ WENGE
-  * DARK ANTHRACITE
-  * WOOD-LIKE ANTHRACITE

EXCLUSIVE COLORS

-  * TURNER OAK

❄️❄️ COLORS AVAILABLE UNTIL OUT OF STOCK

STANDARD COLORS

- WHITE *
- WOOD-LIKE WHITE 
- LIGHT GREY 
- CONCRETE 
- BLEACHED OAK 
- SONOMA OAK 
- SHEFFIELD OAK 
- WINCHESTER *
- GOLDEN OAK *
- DARK WALNUT *
- RUSTICAL OAK ***
- DARK MAHOAGANY 
- SWAMP OAK *
- WENGE ***
- DARK ANTHRACITE *
- WOOD-LIKE ANTHRACITE *

EXCLUSIVE COLORS

- TURNER OAK *

COLORS AVAILABLE UNTIL OUT OF STOCK ***

ANTI-BURGLARY DOORS WITH EMBOSSING



EMBOSSING T46

	RC	Rw	EI	Ud
SENATOR E	2	28	X	1,4
HETMAN 47	3	29	X	X
HETMAN 55	3	29	X	1,4
BATORY 47	X	X	X	X
BATORY 55	X	X	X	X
VERDI	2	42	X	1,4
MOZART	3	43	X	1,6
AMADEO	X	X	X	X
SPARK I	2	37	30	X
SPARK II	3	42	30	X

AVAILABLE SIZES:
80N, 80E, 90N, 90E, 100N, 100E

SIZE 100N, 100E ONLY AVAILABLE IN COLORS MARKED WITH *

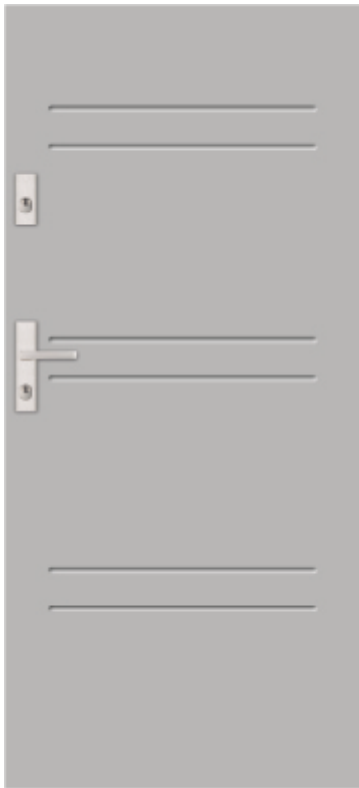

T47



T48



T49



T50

-  * WHITE
-  WOOD-LIKE WHITE
-  LIGHT GREY
-  CONCRETE
-  BLEACHED OAK
-  SONOMA OAK
-  SHEFFIELD OAK
-  * WINCHESTER
-  * GOLDEN OAK
-  * DARK WALNUT
-  ** RUSTICAL OAK
-  DARK MAHOGANY
-  * SWAMP OAK
-  ** WENGE
-  * DARK ANTHRACITE
-  * WOOD-LIKE ANTHRACITE

EXCLUSIVE COLORS

-  * TURNER OAK

** COLORS AVAILABLE UNTIL OUT OF STOCK

STANDARD COLORS

- WHITE *
- WOOD-LIKE WHITE 
- LIGHT GREY 
- CONCRETE 
- BLEACHED OAK 
- SONOMA OAK 
- SHEFFIELD OAK 
- WINCHESTER *
- GOLDEN OAK *
- DARK WALNUT *
- RUSTICAL OAK ***
- DARK MAHOAGANY 
- SWAMP OAK *
- WENGE ***
- DARK ANTHRACITE *
- WOOD-LIKE ANTHRACITE *

EXCLUSIVE COLORS

- TURNER OAK *

COLORS AVAILABLE UNTIL OUT OF STOCK ***

ANTI-BURGLARY DOORS WITH EMBOSSING



EMBOSSING T51

	RC	Rw	EI	Ud
SENATOR E	2	28	X	1,4
HETMAN 47	3	29	X	X
HETMAN 55	3	29	X	1,4
BATORY 47	X	X	X	X
BATORY 55	X	X	X	X
VERDI	2	42	X	1,4
MOZART	3	43	X	1,6
AMADEO	X	X	X	X
SPARK I	2	37	30	X
SPARK II	3	42	30	X

AVAILABLE SIZES:
80N, 80E, 90N, 90E, 100N, 100E

SIZE 100N, 100E ONLY AVAILABLE IN COLORS MARKED WITH *

ANTI-BURGLARY DOORS WITH EMBOSSING

STANDARD COLORS



T52



T53



T54



T58

-  * WHITE
-  WOOD-LIKE WHITE
-  LIGHT GREY
-  CONCRETE
-  BLEACHED OAK
-  SONOMA OAK
-  SHEFFIELD OAK
-  * WINCHESTER
-  * GOLDEN OAK
-  * DARK WALNUT
-  ** RUSTICAL OAK
-  DARK MAHOGANY
-  * SWAMP OAK
-  ** WENGE
-  * DARK ANTHRACITE
-  * WOOD-LIKE ANTHRACITE

EXCLUSIVE COLORS

-  * TURNER OAK

** COLORS AVAILABLE UNTIL OUT OF STOCK

STANDARD COLORS

- WHITE *
- WOOD-LIKE WHITE 
- LIGHT GREY 
- CONCRETE 
- BLEACHED OAK 
- SONOMA OAK 
- SHEFFIELD OAK 
- WINCHESTER *
- GOLDEN OAK *
- DARK WALNUT *
- RUSTICAL OAK ***
- DARK MAHOAGANY 
- SWAMP OAK *
- WENGE ***
- DARK ANTHRACITE *
- WOOD-LIKE ANTHRACITE *

EXCLUSIVE COLORS

- TURNER OAK *

COLORS AVAILABLE UNTIL OUT OF STOCK ***

ANTI-BURGLARY DOORS WITH EMBOSSING



EMBOSSING T59

	RC	Rw	EI	Ud
SENATOR E	2	28	X	1,4
HETMAN 47	3	29	X	X
HETMAN 55	3	29	X	1,4
BATORY 47	X	X	X	X
BATORY 55	X	X	X	X
VERDI	2	42	X	1,4
MOZART	3	43	X	1,6
AMADEO	X	X	X	X
SPARK I	2	37	30	X
SPARK II	3	42	30	X

AVAILABLE SIZES:
80N, 80E, 90N, 90E, 100N, 100E

SIZE 100N, 100E ONLY AVAILABLE IN COLORS MARKED WITH *

ANTI-BURGLARY DOORS WITH EMBOSSING

STANDARD COLORS



T60



T61



T62



T63

-  WHITE
-  WOOD-LIKE WHITE
-  LIGHT GREY
-  CONCRETE
-  BLEACHED OAK
-  SONOMA OAK
-  SHEFFIELD OAK
-  WINCHESTER
-  GOLDEN OAK
-  DARK WALNUT
-  RUSTICAL OAK
-  DARK MAHOGANY
-  SWAMP OAK
-  WENGE
-  DARK ANTHRACITE
-  WOOD-LIKE ANTHRACITE

EXCLUSIVE COLORS

-  TURNER OAK

 COLORS AVAILABLE UNTIL OUT OF STOCK





ANTI-BURGLARY DOORS

WITH APPLICATIONS

STANDARD COLORS



EXCLUSIVE COLORS



COLORS AVAILABLE UNTIL OUT OF STOCK ***

ANTI-BURGLARY DOORS WITH APPLICATIONS

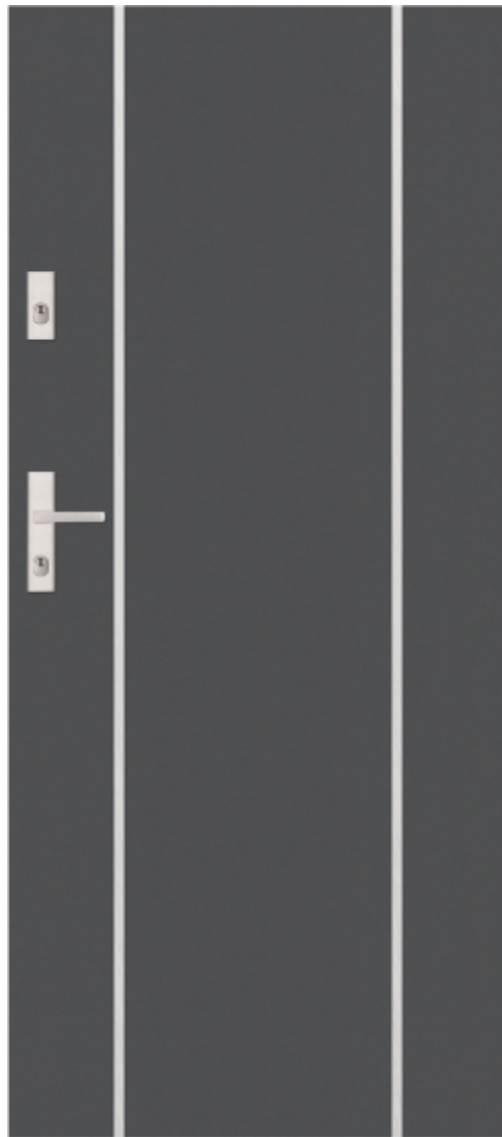

APPLICATION A8

	RC	Rw	EI	Ud
SENATOR E	2	28	X	1,4
HETMAN 47	3	29	X	X
HETMAN 55	3	29	X	1,4
BATORY 47	X	X	X	X
BATORY 55	X	X	X	X
VERDI	2	42	X	1,4
MOZART	3	43	X	1,6
AMADEO	X	X	X	X
SPARK I	2	37	30	X
SPARK II	3	42	30	X

AVAILABLE SIZES:

80N, 80E, 90N, 90E, 100N, 100E WIDTH

AT EXTRA CHARGE PLN 100 - 220.00

DOORS IN SIZE 100N, 100E ARE ONLY AVAILABLE IN COLORS MARKED WITH *

OTHER MODELS OF THE APPLICATIONS CAN BE FOUND ON PAGE 139 OF THE CATALOG



A7



A10



A11



A21

-  WHITE
-  WOOD-LIKE WHITE
-  LIGHT GREY
-  CONCRETE
-  BLEACHED OAK
-  SONOMA OAK
-  SHEFFIELD OAK
-  WINCHESTER
-  GOLDEN OAK
-  DARK WALNUT
-  RUSTICAL OAK
-  DARK MAHOGANY
-  SWAMP OAK
-  WENGE
-  DARK ANTHRACITE
-  WOOD-LIKE ANTHRACITE

EXCLUSIVE COLORS

-  TURNER OAK

 COLORS AVAILABLE UNTIL OUT OF STOCK



TECHNICAL DOORS



STRUCTURE

TECHNICAL



40 MM THICK LEAF WITH TRIANGULAR ABUTMENT, MADE OF GALVANIZED LAMINATED METAL SHEET 0.5 MM THICK, FILLED WITH FOAMED POLYSTYRENE

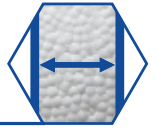

PLATE HINGE Z2



BOTTOM LOCK



STEEL FRAME WITH PROFILE FD-25/21/N/O MADE OF METAL SHEET 1-1.2 MM THICK, PAINTED IN THE LEAF COLOR

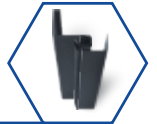

SAFE HANDLE



KEY-KEYINSERT



OPTIONS FOR MANUFACTURING ATAN EXTRA CHARGE

FRAMES					THRESHOLDS		
	FD-21/N	FD-21/C	FD-21/B	FD-22		STEEL THRESHOLD 21/N	THRESHOLD 21/B/C
VENTILATION GRILLES							
	PVC VENTILATION GRILLE WHITE	PVC VENTILATION GRILLE ASH	PVC VENTILATION GRILLE BROWN	PVC VENTILATION GRILLE BLACK	INOX VENTILATION GRILLE		
VENTILATION SLEEVE							
	WHITE VENTILATION SLEEVE	ASH VENTILATION SLEEVE	BROWN VENTILATION SLEEVE	BLACK VENTILATION SLEEVE			



RAL9010
WHITE



RAL7035
ASH



RAL8017
BRONZE



RAL7016
ANTHRACITE

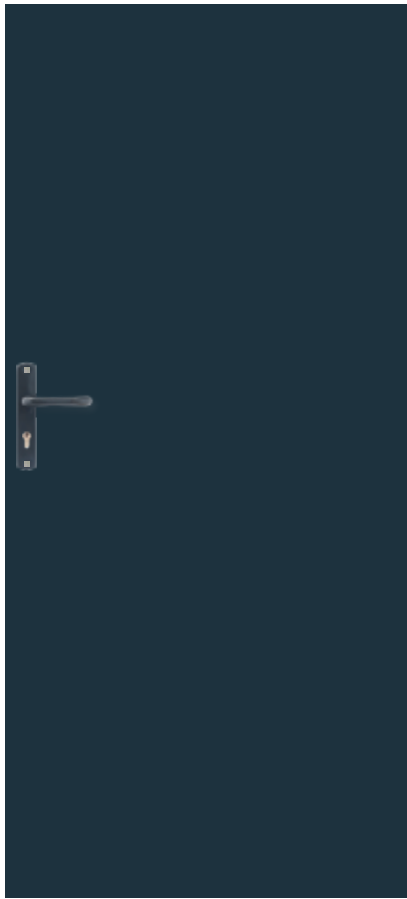

RAL 7016
G

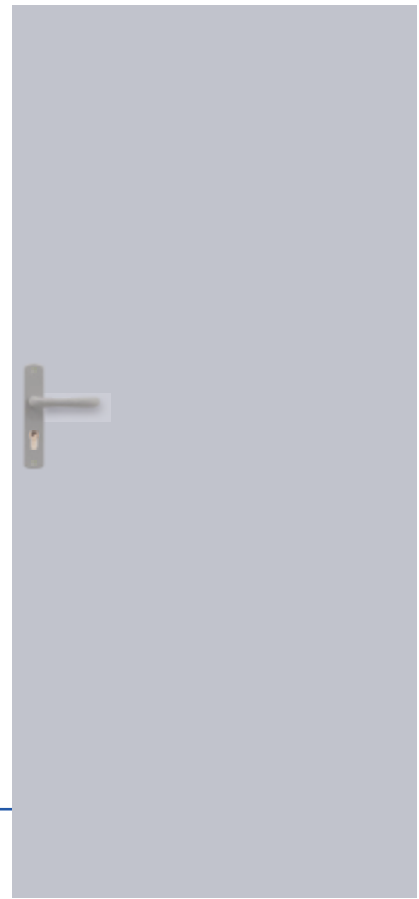

RAL 7035
G

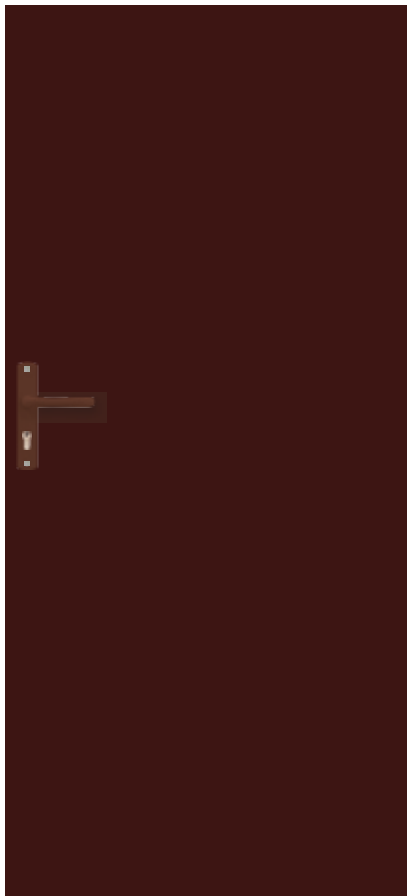

RAL 8017
G

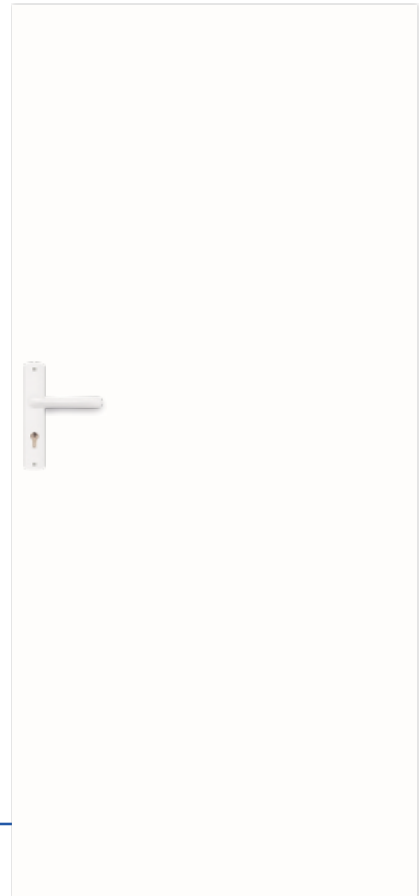

RAL 9010
G



RAL 7035
G /ST 1

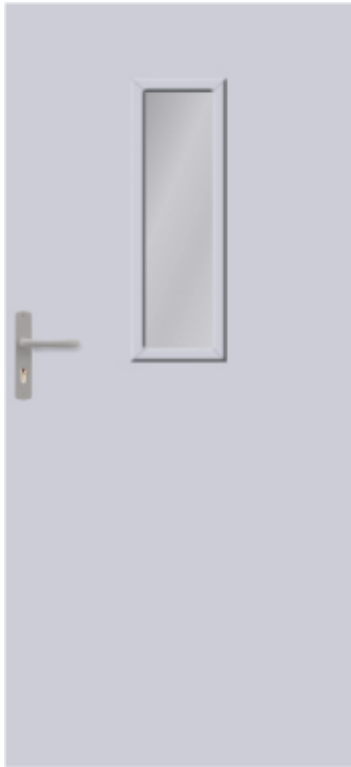

RAL 7016
G /ST 2



RAL 8017
G /ST 3



FULL FRAME FD-25/21/N/O		
OTHER MANUFACTURING OPTIONS	FULL FRAME FD-21/N	
	FULL FRAME FD-21/C	
	FULL FRAME FD-21/B	
	STEEL THRESHOLD EXTRA CHARGE	
	WITH FRAME FD-25/21/N/O	GLAZED ST1 TRANSPARENT
		GLAZED ST2 TRANSPARENT
		GLAZED ST3 TRANSPARENT
		GLAZED ST1 MILK
		GLAZED ST2 MILK
		GLAZED ST3 MILK
		WITH PVC VENTILATION GRILLE OR VENTILATION SLEEVE
		WITH INOX VENTILATION GRILLE
		WITH WC LOCK (WITH OLARIX WC HANDLE)
WITH TOP LOCK		

AVAILABLE SIZES: 60, 70,80, 80E, 90, 90E, 100, 100E

TECHNICAL DOORS | WITH PANELS

AVAILABLE COLORS



RAL 8017
G
CENTER PANEL AND
BOTTOM PANEL WITH BUILT-IN
VENTILATION GRILLE



RAL 7016
G
CENTER PANEL AND
BOTTOM PANEL



RAL 9010
G
BOTTOM PANEL



FULL DOOR LEAF WITHOUT DOOR FRAME	
FULL DOOR FRAME FD25/21/N/O	
OTHER MANUFACTURING OPTIONS	BOTTOM PANEL WITH BUILT-INVENTILATION GRILLE INOX/BLACK DOUBLE-SIDED
	BOTTOM PANEL INOX/BLACK SINGLE-SIDED
	INOX/BLACK DOUBLE-SIDED BOTTOM PANEL
	INOX/BLACK SINGLE-SIDED CENTER PANEL
	INOX/BLACK DOUBLE-SIDED CENTER PANEL
	INOX BOTTOM PANEL +INOX SINGLE-SIDED CENTER PANEL
	INOX BOTTOM PANEL +INOX DOUBLE-SIDED CENTER PANEL
	BOTTOM PANEL WITH VENTILATION GRILLE FUNCTION +INOX DOUBLE-SIDED CENTER PANEL

AVAILABLE SIZES: 60, 70,80, 80E, 90, 90E, 100, 100E



GARAGE SECTIONAL GATES



SECTIONAL GARAGE DOORS



Segmented garage doors are used in single and multi-family homes. The individual preferences of our customers are reflected in personalized products prepared on special order. A selected color scheme of high-quality door panels and a wide selection of exterior door laminates allow you to create well composed color sets that are a callingcard of the house.

For convenience of use, garage doors can be equipped with an automatic drive. Our offer includes automation from leading gate manufacturers: Somfy and Beninca.



GATES | SAFETY OF USE AS STANDARD

- A mechanism to prevent the door from falling down in the event of a spring breakage
- Panels with a secure lock to prevent accidental finger pinching
- Special guides to prevent rollers from falling out
- Omega trapezoidal reinforcement protecting against bending of panels with a length of 5 meters and longer
- Amperometric obstacle detection system – used to detect possible obstacles that may appear on the path of the moving gate. Thanks to this function, when an obstacle is encountered, the actuator stops the gate and changes the direction of its movement

STANDARD EQUIPMENT

- Leaf made of 40 mm thick panels filled with polyurethane foam made of galvanized steel sheet
- Support frame – angles and guides made of galvanized steel profiles 2 mm thick
- Front torsion springs with standard number of 15000 cycles
- Central and side hinges are made of galvanized steel sheet

The lock, handle, grip, drive and bolt are added to the order at the customer's request.

THERMAL PERMEABILITY

Panels used in the production of our doors are distinguished by the thermal insulation parameter at the level of $U_d = 0.74 \text{ W}/(\text{m}^2 \cdot \text{K})$



COLORS OF THE SLICK GATE PANELS



WINCHESTER

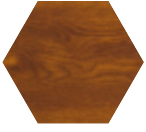

GOLDEN OAK



DARK WALNUT



SWAMP OAK



DARK ANTHRACITE

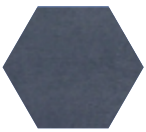

WOOD-LIKE ANTHRACITE

COLORS OF THE WOODGRAIN GATE PANELS



WHITE

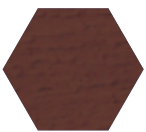

BROWN

SECTIONAL GARAGE DOORS

PANEL WITHOUT EMBOSSING



GATE IN THE WINCHESTER COLOR



PANEL WITHOUT EMBOSSING



GATE IN THE DARK ANTHRACITE COLOR



OTHER MANUFACTURING OPTIONS

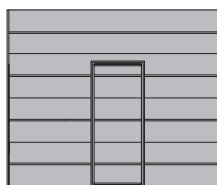

GATE WITH PASS-THROUGH DOOR AND LOW THRESHOLD

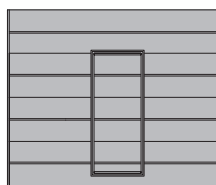

GATE WITH PASS-THROUGH DOOR AND HIGH THRESHOLD

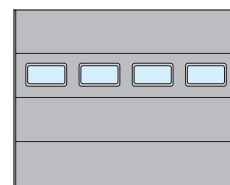

PANEL WITH WINDOW PANE

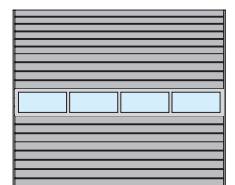

ALUMINUM SECTION PANEL

SECTIONAL GARAGE DOORS

NARROW PANEL WITH EMBOSSING



WHITE DOOR | WOODGRAIN



PANEL WITH WIDE EMBOSSING



GOLD OAK GATE | SLICK



OTHER MANUFACTURING OPTIONS

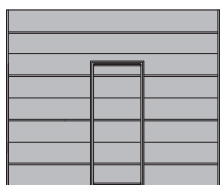

GATE WITH PASS-THROUGH DOOR AND LOW THRESHOLD

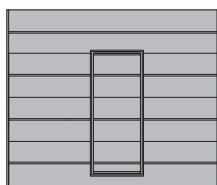

GATE WITH PASS-THROUGH DOOR AND HIGH THRESHOLD

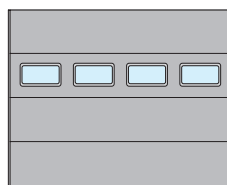

PANEL WITH WINDOW PANE

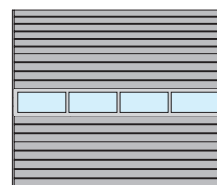

ALUMINUM SECTION PANEL

COLORS OF THE SLICK GATE PANELS



WINCHESTER



GOLDEN OAK



DARKWALNUT



SWAMP OAK



DARK ANTHRACITE

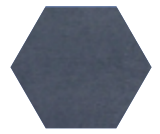

WOOD-LIKE ANTHRACITE

COLORS OF THE WOODGRAIN GATE PANELS

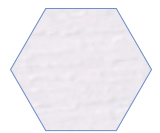

WHITE



BROWN

GATES | SOMFY GATE AUTOMATION

Somfy – a world leader among manufacturers of automation for gates. All Somfy products are tested under the most demanding conditions, which translates into their durability and reliability. Somfy drives are equipped with a chain tension as standard, which can be replaced with a kevlar belt at the customer's request.

SOMFY DEXXO OPTIMO

Ideal for sectional gates with a maximum area of up to 10 m².

SOMFY DEXXO OPTIMO RTS	
124V MOTOR WITH BUILT-IN CONTROL PANEL AND RTS RADIO	
800 N DRIVE GUIDE WITH CHAIN	2.9 M TESTED FOR 36,500 CYCLES
	3.5M TESTED FOR 36,500 CYCLES
12CHANNEL REMOTE CONTROL SOMFY KEYTIS 2	

SOMFY DEXXO PRO

Designed for gates up to 15 m².

SOMFY DEXXO PRO	
124V MOTOR WITH BUILT-IN CONTROL PANEL AND RTS RADIO	
1000 N DRIVE GUIDE WITH CHAIN	2.9 M TESTED FOR 36,500 CYCLES
	3.5M TESTED FOR 36,500 CYCLES
24 CHANNEL REMOTE CONTROL SOMFY KEYGO RTS	



You are just starting an adventure with new technologies and you do not know yet which home devices you will want to use with the application? Choose TaHoma and Smart IO drive – you will manage the gate from your phone and it will also allow you to manage the central heating, roller shutters or lighting.



GATES | BENINCA GATE AUTOMATION

JIMs are PREMIUM products with the best value for your money. They have a kevlar belt tension, thanks to which the actuators work extremely quietly and smoothly. The kevlar belt is reinforced with three or four (depending on the model) steel ropes. Two basic JIM actuator models are produced: JIM.3 and JIM.4.

BENINCA JIM.3

Designed for gates up to 11 m².

BENINCA JIM.3	
124V MOTOR WITH BUILT-IN ENCODER AND RECEIVER	
GUIDE FOR 600 N DRIVE WITH BELT	PTC.3 FOR GATES UP TO 2.5M HIGH
	PTCL.4 FOR GATES UP TO 3.5M HIGH
ONE 2CHANNEL REMOTE CONTROL TO.GO2VA	

BENINCA JIM.4

Ideal for sectional gates with a maximum area of up to 22 m².

BENINCA JIM.4	
124V MOTOR WITH BUILT-IN ENCODER AND RECEIVER	
GUIDE FOR 1200N DRIVE WITH BELT	PTC.3 FOR GATES UP TO 2.5M HIGH
	PTCL.4 FOR GATES UP TO 3.5M HIGH
ONE 2CHANNEL REMOTE CONTROL TO.GO2VA	



TABLE OF MARKINGS FOR THE DIMENSIONS OF SECTIONAL GARAGE DOORS

WIDTH OF THE OPENING, ORDER DIMENSION		So	
HOLE HEIGHT, ORDER DIMENSION		Ho	
LUMEN HEIGHT OF THE ENTRY		Hw	Ho -150 mm
LUMEN WIDTH OF THE ENTRY		Sw	So
MINIMUM REQUIRED LINTEL HEIGHT		N	
FRONT GUIDE, FRONT SPRINGS (LINTEL)	MANUAL GATE	N	200 mm
	AUTOMATIC GATE	N	
REAR GUIDE, REAR GUIDE SPRINGS	MANUAL GATE	N	100 mm
	AUTOMATIC GATE	N	150 mm
MINIMUM DEPTH OF ROOM WITH FREE SPACE UNDER THE CEILING		D	Lpn +100 mm
MINIMUM WIDTH OF THE LEFT LATERALSPACE		Bl	80 mm
MINIMUM WIDTH OF THE RIGHT LATERAL SPACE		Br	80 mm
GATE GUIDE LENGTH		Lp	Ho +460 mm
DRIVE GUIDE LENGTH		Lpn	3300 lub 3900 mm

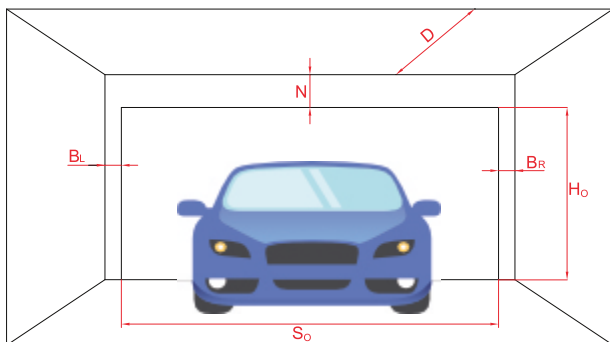

Ho –opening height

So –opening width

N –minimum required lintel height

D –minimum depth of room with free space under the ceiling

Br –minimum width of the right lateral space

Bl –minimum width of the left lateral space

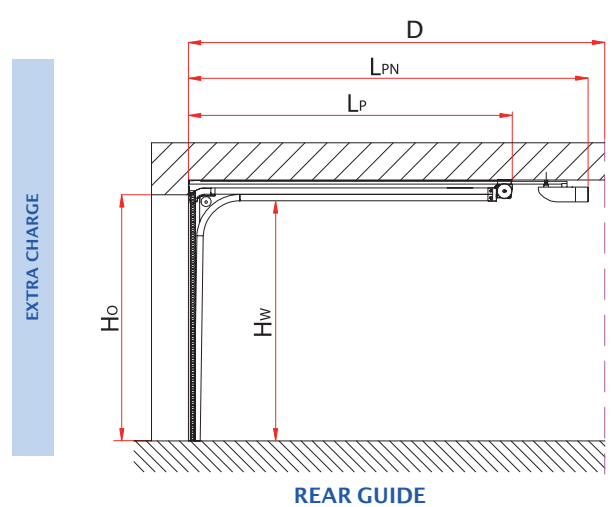
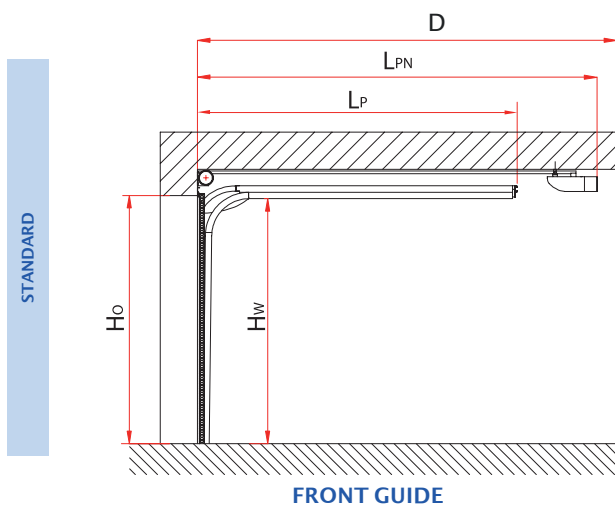



INDUSTRIAL SECTIONAL GATES



INDUSTRIAL SECTIONAL GATES

Industrial sectional gates are used in multi-family residential buildings, public facilities and industrial facilities. Due to their purpose and specific application, industrial gates can be equipped with windows, aluminum panels, ventilated panels or passage doors. For convenience of use, industrial gate can be equipped with GfA Elektromaten and Beninca drives.

INDUSTRIAL SECTIONAL GATES | STRUCTURE

Standard equipment:

- Leaf made of 40 mm thick panels filled with polyurethane foam made of galvanized steel sheet
- Support frame - angles and guides made of galvanized steel profiles 2 mm thick
- Torsion springs at the front

The lock, handle, grip, drive and bolt are added to the order at the customer's request.

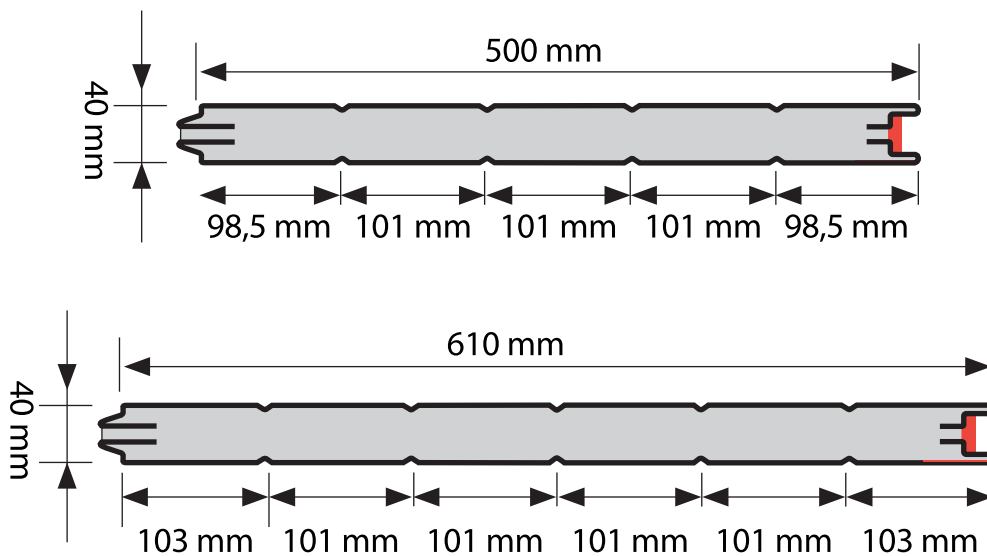

INDUSTRIAL SECTIONAL GATES | RAL VARNISH STANDARD COLORS AVAILABLE

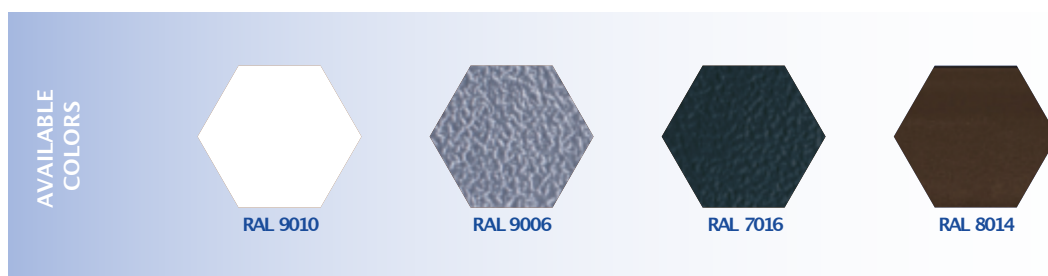

INDUSTRIAL SECTIONAL GATES | EXAMPLES OF GATE DESIGNS

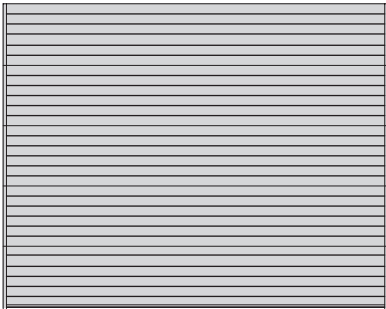

GATE WITH NARROW EMBOSSING

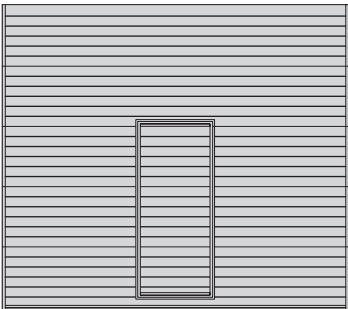

GATE WITH PASSAGE DOOR

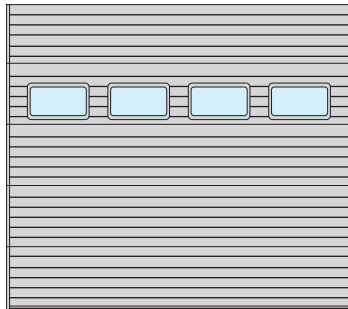

GATE WITH WINDOWS

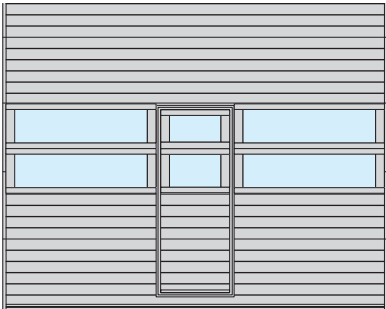

GATES WITH PASSAGE DOORS AND PANELS WITH ALUMINIUM GLAZED SECTION

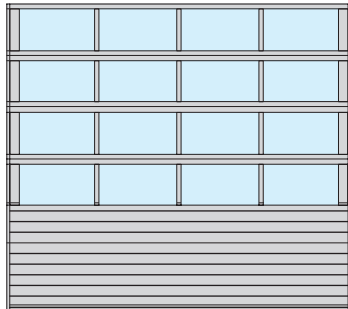
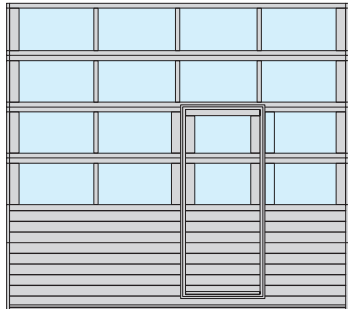

GATE WITH PANELS WITH ALUMINIUM GLAZED SECTION

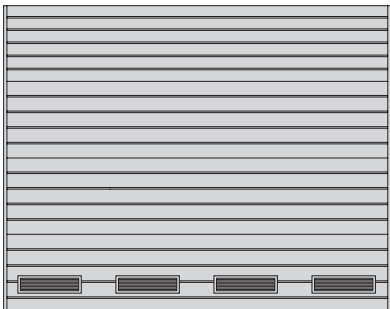

GATE WITH VENTILATION GRILLES

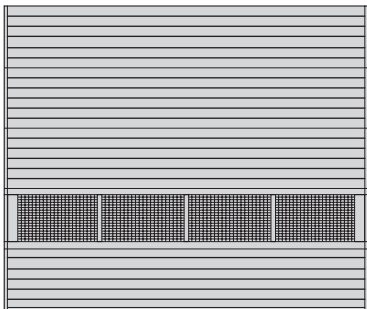

GATE WITH VENTILATED PANEL



DIMENSIONING TABLE FOR INDUSTRIAL GATES

	STANDARD GUIDE	STANDARD GUIDE WITH ELEVATION	LOW GUIDE	ANGULAR GUIDE	ANGULAR GUIDE WITH ELEVATION	VERTICAL GUIDE SHAFT AT THE HEIGHT OF THE LINTEL
Pp	+	+		+	+	
Pt			+			
Sw	So	So	So	So	So	So
Hw	Ho	Ho	Ho - 35 ¹ , Ho - 135 ²	Ho	Ho	Ho
N	420 mm	420 mm + N	200 mm [Nr] 300 mm [NA]	420 mm	420 mm + N	Ho + 300 mm
Br, Bl	80 mm	80 mm	80 mm	80 mm	80 mm	80 mm
B ₁	250 mm	250 mm	250 mm	250 mm	250 mm	250 mm
B ₂	350 mm	350 mm	350 mm	350 mm	350 mm	350 mm
D	Ho + 650 mm	Ho - N + 650 mm	Ho + 1100 mm			

¹FOR HAND GATES

²FOR AUTOMATIC GATES

- Pp - FRONT GUIDE, SPRINGS AT THE FRONT OF THE GATE
- Pt - REAR GUIDE, SPRINGS AT THE BACK OF THE GATE
- So - WIDTH OF THE OPENING, ORDER DIMENSION
- Ho - HOLE HEIGHT, ORDER DIMENSION
- Sw - LUMEN WIDTH OF THE ENTRY
- Hw - LUMEN HEIGHT OF THE ENTRY
- N - MINIMUM HEIGHT OF THE LINTEL
- Nr - MINIMUM HEIGHT FOR MANUALLY OPENED GATES

- Na - MINIMUM HEIGHT FOR AUTOMATIC GATES
- D - MINIMUM DEPTH OF THE ROOM WITH FREE SPACE UNDER THE CEILING
- Br - MINIMUM WIDTH OF THE RIGHT LATERAL SPACE
- Bl - MINIMUM WIDTH OF THE LEFT LATERAL SPACE
- B₁ - MINIMUM WIDTH OF THE SIDE SPACE FOR GATES WITH WINCH
- B₂ - MINIMUM WIDTH OF THE SIDE SPACE FOR GATES WITH AUTOMATION

STANDARD GUIDE

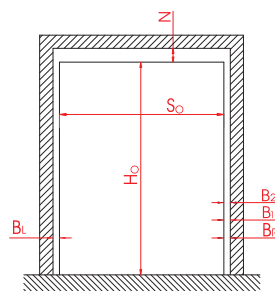
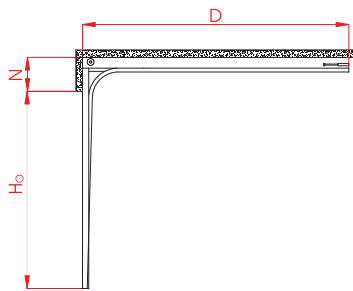

VIEW FROM THE INSIDE



ANGULAR GUIDE

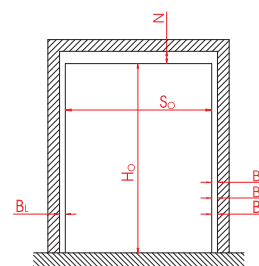
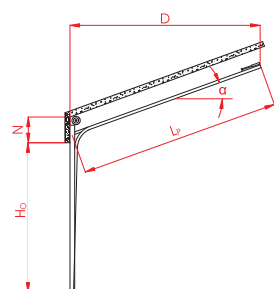

VIEW FROM THE INSIDE



STANDARD GUIDE WITH ELEVATION

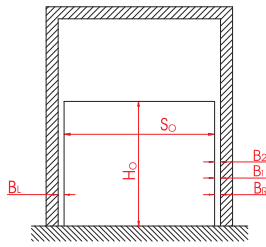
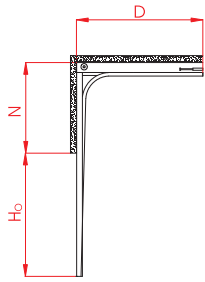

VIEW FROM THE INSIDE



ANGULAR GUIDE WITH ELEVATION

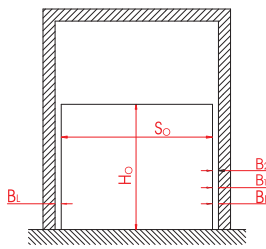
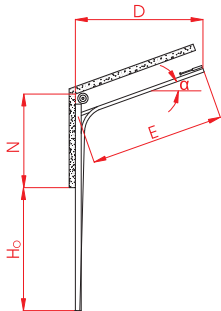

VIEW FROM THE INSIDE



VERTICAL GUIDE [SHAFT AT THE HEIGHT OF THE LINTEL]

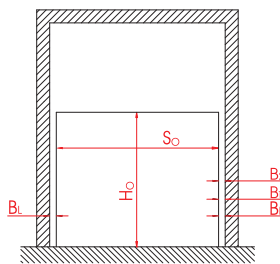
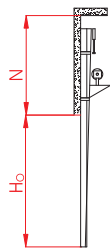

VIEW FROM THE INSIDE



REAR LOW GUIDE

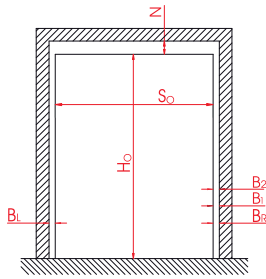
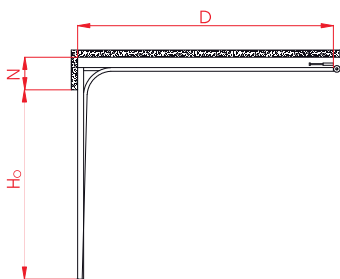

VIEW FROM THE INSIDE





The GfA Elektromaten drive is mounted on a drive shaft mounted to the lintel. Lateral locking with a microswitch can be used (additional equipment table).

When ordering a drive in accordance with the table of dimensions of the available lead, the ordered set includes:

GFA	DRIVE TYPE		
	SE 5	SE 9	SE 14
GATE SURFACE	up to 16m ² So up to 5000 mm Ho up to 5000 mm	up to 26 m ²	over 26 m ²
STANDARD EQUIPMENT	<ul style="list-style-type: none"> ■ TS-970 CONTROL PANEL: UP-STOP-DOWN [AUTOMATIC] ■ POWER SUPPLY 3N ~400 V ■ ELECTRONIC LIMIT SWITCH ACCESSIBLE FROM THE OPERATOR LEVEL ■ OPTICAL SAFETY STRIP OF THE LOWER GATE EDGE: TRANSMITTER + RECIEVER ■ MECHANISM FOR EMERGENCY MANUAL OPERATION TYPE SK WITH CHAIN 		

GFA ELEKTROMATEN DRIVES

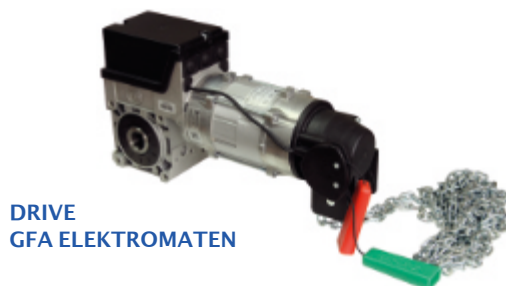

DRIVE
GFA ELEKTROMATEN



TS-970 GATE CONTROLLER

A novelty in the offer are Italian drives for industrial gates –Beninca.

The Jack.24 model features:

- **compact size** (11cm wide) for quick and easy installation even in confined spaces
- ideal for automation of large gates (up to 35 m²) or when **intensive use** is required
- **the encoder** guarantees the highest safety and precision when moving the gate
- **built-inSTC system** for precise torque management
- guarantee of being operational even in the event of a power failure thanks to batteries that can be perfectly integrated into the engine (two 1.2Ah batteries)
- **built-inbattery charger**
- **anti-crushsystem** with amperometric obstacle detection
- **built-inquick release system for manual control**



Actuator JACK.24 is available in two versions:

BENINCA	TYPE	
	JACK24.50	JACK24.80
GATE SURFACE	up to 20 m ²	up to 35 m ²
TORQUE	50 Nm	80 Nm

GFA ELEKTROMATEN GATE AUTOMATION



CHAIN DRIVE



PANEL WITH ALUMINUM SECTION



PVC VENTILATION GRILLE, COLORS: WHITE, GRAY,BROWN, BLACK



PVC FRAME WINDOW

ADDITIONAL EQUIPMENT

PASSAGE DOOR (830 X 2210MM PASSAGE LUMEN) WITH THRESHOLD 140 MM

PASSAGE DOOR (830 X 2210MM PASSAGE LUMEN) WITH THRESHOLD 28 MM

HANDLE WITH LOCK

PVC VENTILATION GRILLE (OUTER DIM. 460 MM X 135MM)

WINDOW (FRAME OUTER SIZE 336MM X 640 MM)

PANELS OUTSIDE THE STANDARD COLLECTION

ALUMINIUM GLAZED PANEL

DOUBLE-SIDED HANDLE

BOLT -ADDITIONAL LOCK FROM THE INSIDE

LOW GUIDE WITH A REAR SPRING

SOMFY -DRIVES AND ACCESSORIES

SOMFY DEXXO OPTIMO DRIVE FOR 10M2

SOMFY DEXXO OPTIMO DRIVE FOR 15M2

SOMFY DEXXO SMART 800 IO DRIVE (2 KEYGO IO REMOTE CONTROLS)

SOMFY DEXXO SMART 1000 IO DRIVE (2 KEYGO IO REMOTE CONTROLS)

SOMFY DRIVE GUIDE 2.9 UP TO 2.4 M HEIGHT (CHAIN)

SOMFY DRIVE GUIDE 2.9 UP TO 2.4 M HEIGHT (BELT)

SOMFY DRIVE GUIDE 3.5 UP TO 3 M HEIGHT (CHAIN)

SOMFY DRIVE GUIDE 3.5 UP TO 3 M HEIGHT (BELT)

SOMFY 2-CHANNEL REMOTE CONTROL

SOMFY 4-CHANNEL REMOTE CONTROL

SOMFY KEYGO IO 4-CHANNEL REMOTE CONTROL

MASTER PHOTOCELL

EMERGENCY DISCONNECTION OF THE DRIVE BY MEANS OF THE INSERT

EMERGENCY POWER SUPPLY BATTERY

TAHOMA SWITCH PRO

BENINCA -DRIVES AND ACCESSORIES

BENINCA JIM.3 DRIVE UP TO 11M2

BENINCA JIM.4 DRIVE UP TO 22 M2

DRIVE GUIDE PTC.3 UP TO 2.5 M

DRIVE GUIDE PTC.4 UP TO 3.5 M

BENINCA 2-CHANNEL REMOTE CONTROL

BENINCA 4-CHANNEL REMOTE CONTROL

PUPILLA PHOTOCELL

EMERGENCY DISCONNECTION OF THE DRIVE

JACK24.50 UP TO 20 M2

JACK24.50 UP TO 35M2

GFA -INDUSTRIAL DOOR DRIVES AND ACCESSORIES

GFA SE 5 DRIVE

GFA SE 9 DRIVE

GFA SE 14 DRIVE

2-CHANNEL REMOTE CONTROL

4-CHANNEL REMOTE CONTROL

RADIO RECEIVER

DEDICATED FOR INDUSTRIAL GATES

CHAIN GEAR

ANGULAR GUIDE, VERTICAL, WITH ELEVATION

PREPARATION FOR THE ASSEMBLY OF THE DRIVE [ONLY FOR INDUSTRIAL GATES]

DEDICATED FOR FENCE GATES

BENINCA DRIVES FOR DOUBLE-LEAF FENCE GATES UP TO 2.1M

BENINCA DRIVES FOR SLIDING FENCE GATES UP TO 400 KG

BENINCA DRIVES FOR SLIDING FENCE GATES UP TO 500 KG



DOOR MODELS

G

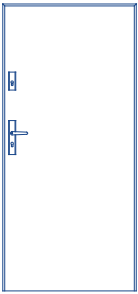

TECHNICAL INFORMATION | FULL DOOR MODELS - SHALLOW EMBOSSED

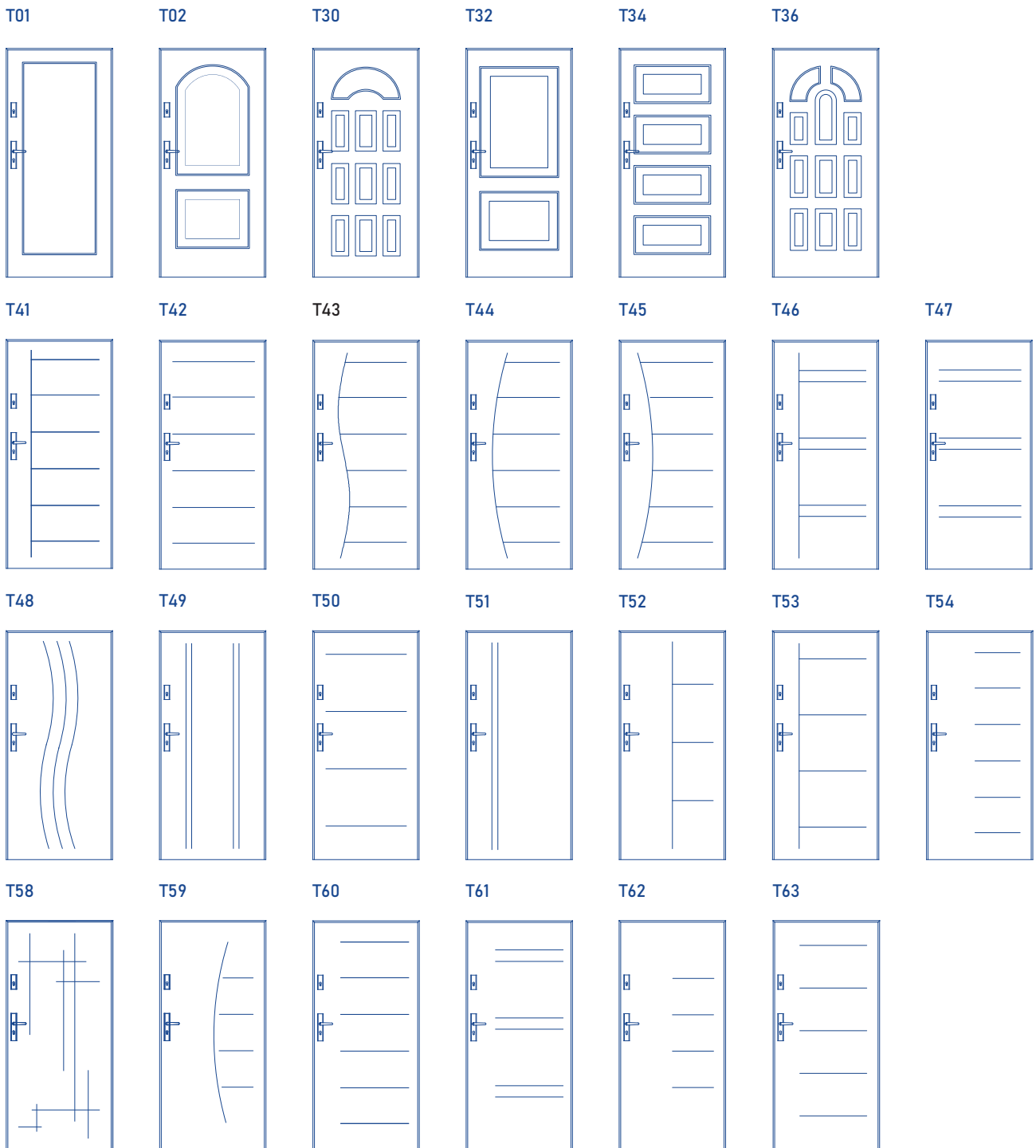

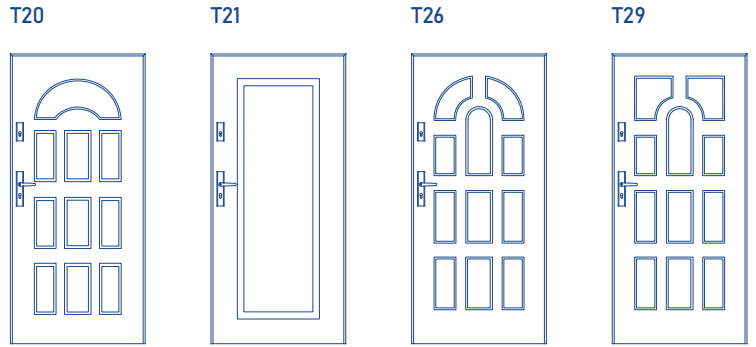

TECHNICAL INFORMATION | DOOR MODELS WITH APPLICATIONS

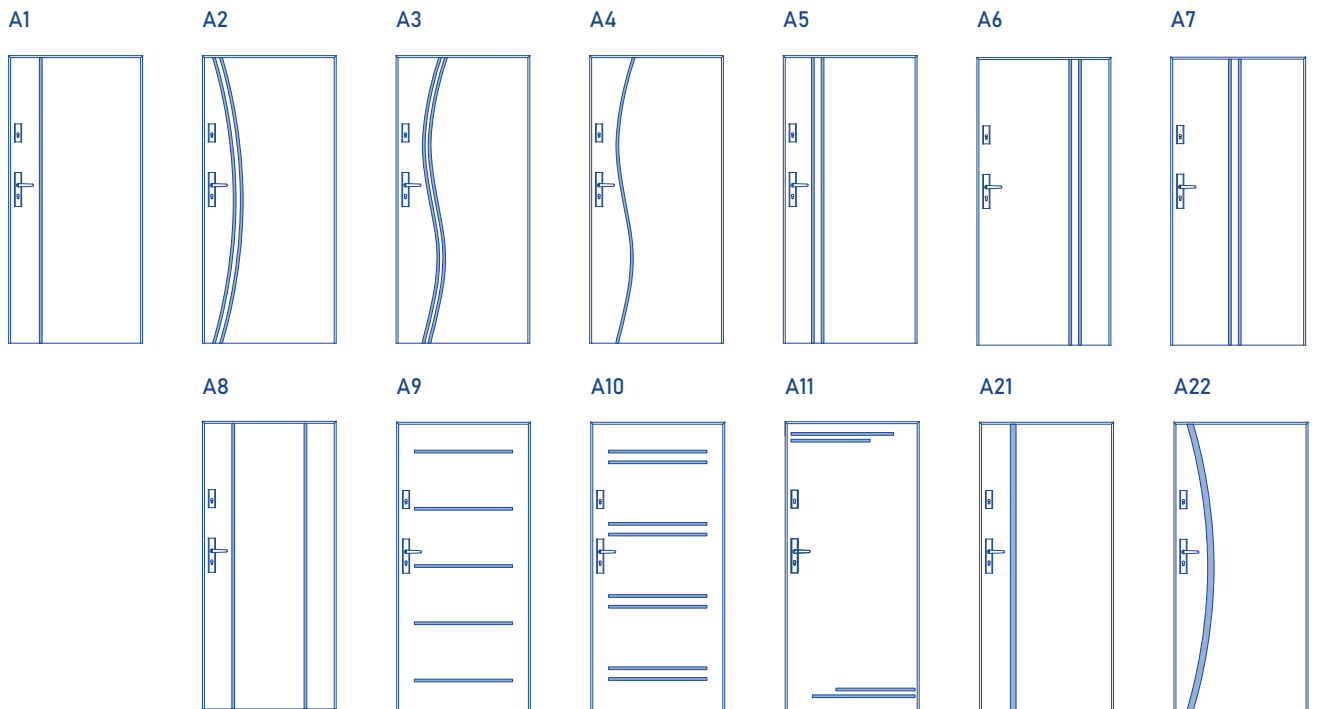

TECHNICAL INFORMATION | DOOR MODELS WITH GLAZING

PVC FRAMES



INOX / BLACK FRAMES

T50 S29

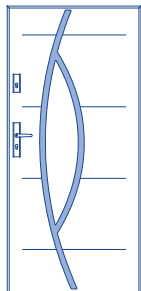

T01 S30

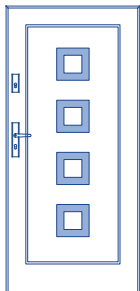

T01 S31

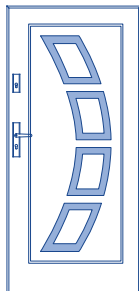

T01 S32

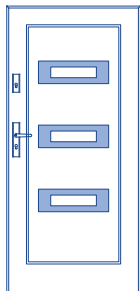

T01 S33

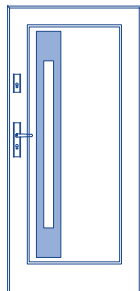

T46 S33

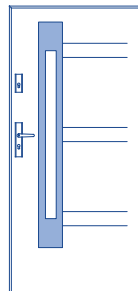

T01 S34

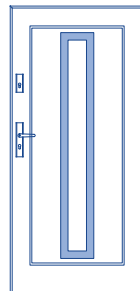

T49 S34

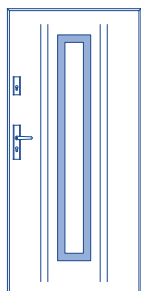

T52 S34

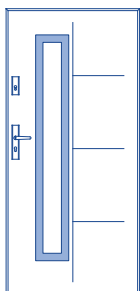

T63 S34

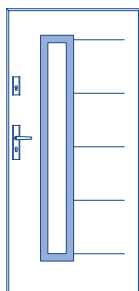

G S35

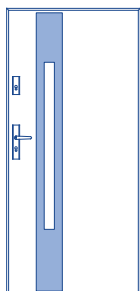

G S36

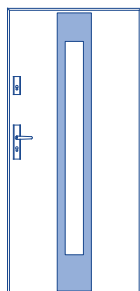

T41 S36

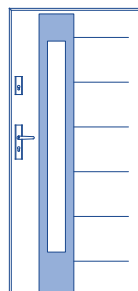

T41 S37

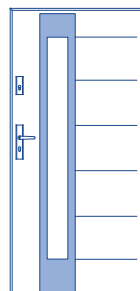

T01 S38

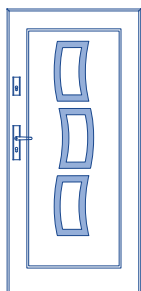

T01 S39

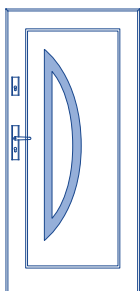

T42 S40

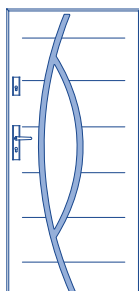

T01 S41

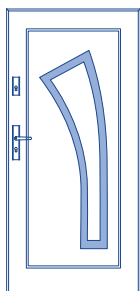

T44 S42

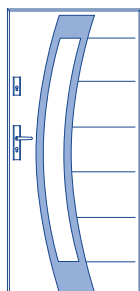

T41 S43

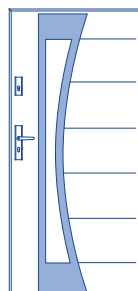

T59 S43

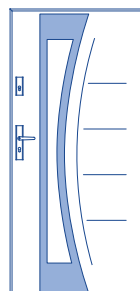

T42 S44

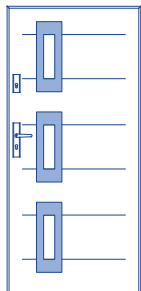

T41 S45

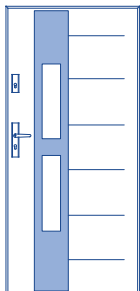

T01 S46

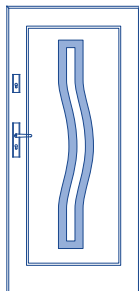

T01 S47

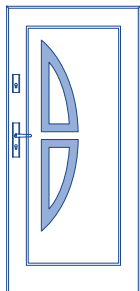

G S48

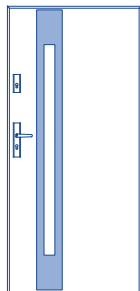

G S49

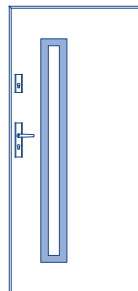

G S51

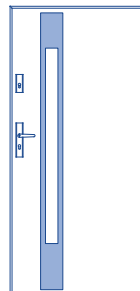

INOX / BLACK FLUSH FRAMES

T60 S50

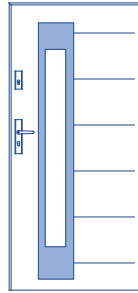

G S53

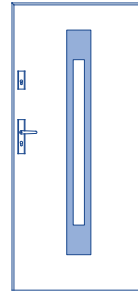

T62 S53

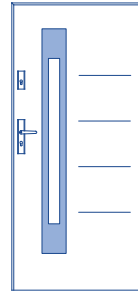

G S54

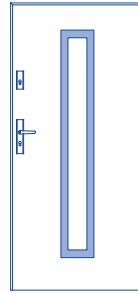

INOX / BLACK NARROW FRAME

T53 S60

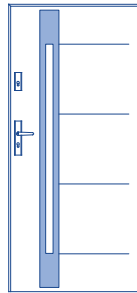

T41 S61

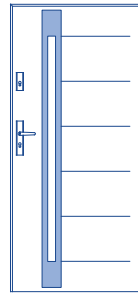

T54 S61

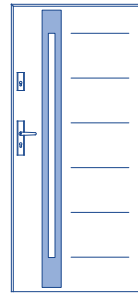

T49 S62

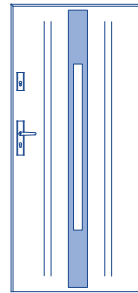

INOX / BLACK NARROW FLUSH FRAME

T48 S70

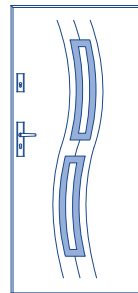

S33
A46 NARROW

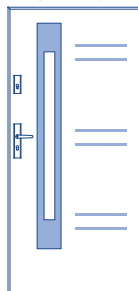

S36
A41 WIDE

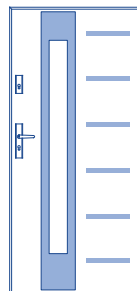

S60
A53 NARROW

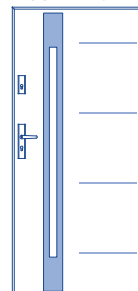

S62
A49 NARROW

